

# Panasonic

**DVCPRO**

Digital Video Cassette Recorder

**AJ-D455P**

## Operating Instructions

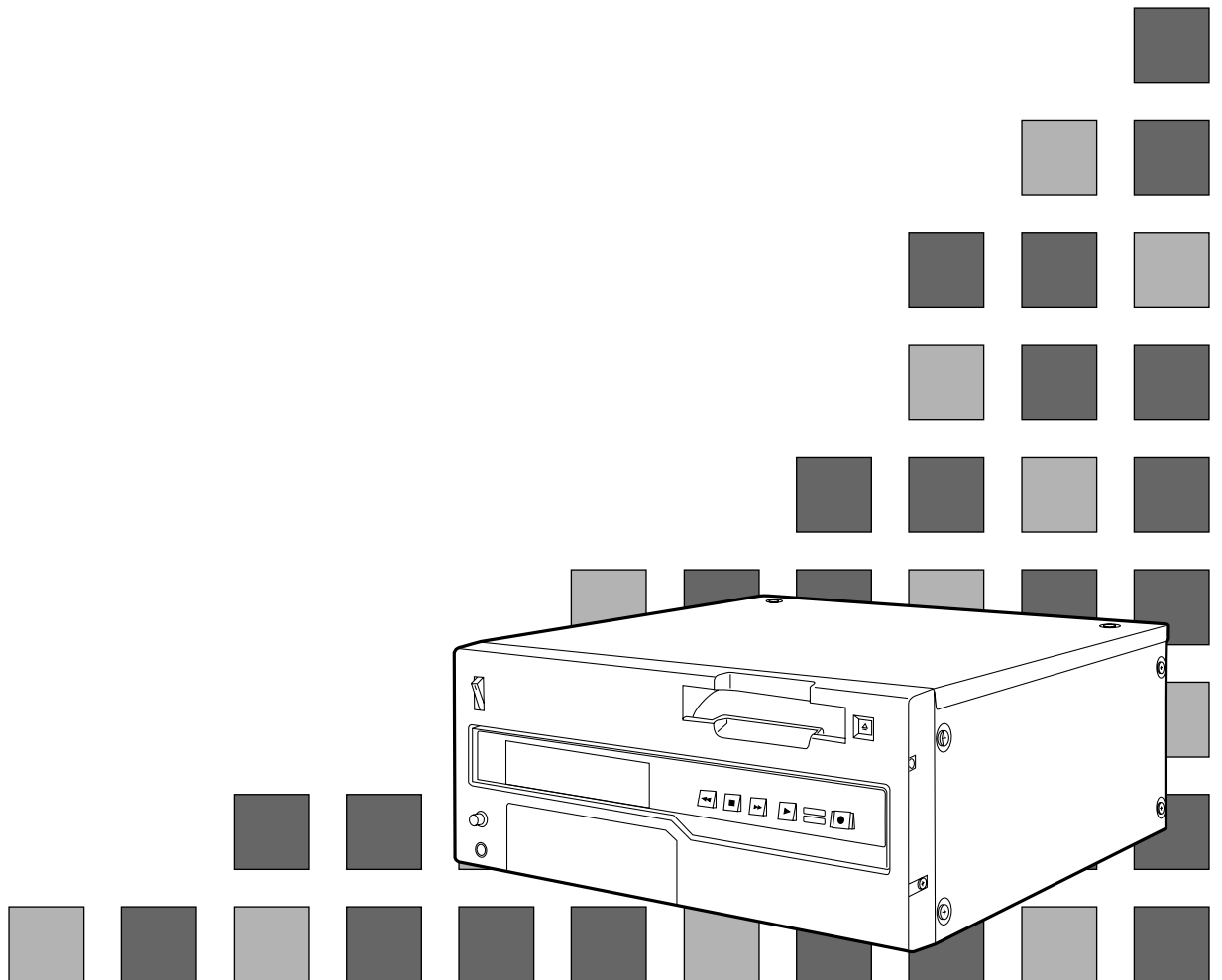

## IMPORTANT

“Unauthorized recording of copyrighted television programs, video tapes and other materials may infringe the right of copyright owners and be contrary to copyright laws.”



The lightning flash with arrowhead symbol, within an equilateral triangle, is intended to alert the user to the presence of uninsulated “dangerous voltage” within the product’s enclosure that may be of sufficient magnitude to constitute a risk of electric shock to persons.



The exclamation point within an equilateral triangle is intended to alert the user to the presence of important operating and maintenance (servicing) instructions in the literature accompanying the appliance.

### CAUTION:

To reduce the risk of fire or shock hazard and annoying interference, use the recommended accessories only.

### THIS APPARATUS MUST BE EARTHED

To ensure safe operation the three-pin plug must be inserted only into a standard three-pin power point which is effectively earthed through the normal house-hold wiring.

Extension cords used with the equipment must be three-core and be correctly wired to provide connection to earth. Wrongly wired extension cords are a major cause of fatalities.

The fact that the equipment operates satisfactorily does not imply that the power point is earthed and that the installation is completely safe. For your safety, if in any doubt about the effective earthing of the power point, consult a qualified electrician.

### WARNING:

To reduce the risk of fire or shock hazard, do not expose this equipment to rain or moisture.

### CAUTION:

TO REDUCE THE RISK OF FIRE OR SHOCK HAZARD, REFER MOUNTING OF THE OPTIONAL INTERFACE BOARD TO AUTHORIZED SERVICE PERSONNEL.

### FCC Note:

This device complies with Part 15 of the FCC Rules. To assure continued compliance follow the attached installation instructions and do not make any unauthorized modifications.

This equipment has been tested and found to comply with the limits for a Class A digital device, pursuant to Part 15 of the FCC Rules. These limits are designed to provide reasonable protection against harmful interference when the equipment is operated in a commercial environment. This equipment generates, uses, and can radiate radio frequency energy and, if not installed and used in accordance with the instruction manual, may cause harmful interference to radio communications. Operation of this equipment in a residential area is likely to cause harmful interference in which case the user will be required to correct the interference at his own expense.

### CAUTION:

Do not install or place this unit in a bookcase, built in cabinet or in another confined space in order to keep well ventilated condition. Ensure that curtains and any other materials do not obstruct the ventilation condition to prevent risk of electric shock or fire hazard due to overheating.

 is the safety information.

# Contents

---

General and Features .....	4
----------------------------	---

---

## Controls and their functions

Controls and their functions .....	6
• Front panel .....	6
• Connector area .....	11
Tapes .....	14

---

## Setup menus

Setup (default settings) .....	15
Setup menus .....	16
• SYSTEM menu .....	20
• USER menu .....	22
• BASIC menu .....	22
• OPERATION menu .....	24
• INTERFACE menu .....	26
• EDIT menu .....	27
• TAPE PROTECT menu .....	30
• TIME CODE menu .....	31
• VIDEO menu .....	33
• AUDIO menu .....	35
• MENU menu .....	37

---

## Time code

Time code/user bit .....	38
Recording internal/external time codes .....	39
Reproducing the time code/user bit .....	40

---

## Functions

Superimpose screen .....	41
Servo reference .....	42

---

## Maintenance

Rack mounting .....	43
Video head cleaning .....	44
Condensation .....	44
Error messages .....	45

---

## Specifications and others

Connector signals .....	48
Printed circuit board .....	50
Specifications .....	51

---

**Before operating this unit, check that all of its accessories are present and accounted for.**

Power cord .....	1 pc
AJ-CS455P Cassette adaptor .....	1 pc

### Option

- AJ-YA455P component serial interface board
- AJ-MA75P Rack mounting adaptor
- AJ-YAD455P Digital video interface board
- AJ-YA752P Audio memory unit

# General and Features

---

This unit is a digital video cassette recorder which uses 1/4-inch tapes.

It incorporates digital compression technology so that the deterioration in picture quality and sound quality resulting from dubbing is significantly minimized compared with existing analog systems.

Furthermore, since it has a compact 4U size and light weight, the unit can be carried around or mounted in a 19-inch rack with ease.

The settings for the unit's setup can be performed while viewing the screen menus on the TV monitor. When DVCPRO cassette tapes are used, both assemble and insert editing can be performed by exercising control from an external component.

## Features

### **Compact size and light weight**

This is a 4U size digital VTR. It can be mounted in a 19-inch rack with ease using the optional rack-mounting adaptors (AJ-MA75P).

### **Up to 184 minutes of recording**

Two sizes of cassette tapes can be used with this unit: M cassette (max. 66 minutes) and L cassette (max. 184 minutes). The width of the tapes measures 1/4 inch to achieve a compact design.

### **Compatibility with consumer products**

This unit can play back consumer-use cassette tapes shot by a digital camera or other consumer component. It can also record on consumer-use cassette tapes using the DV format. A cassette adapter (AJ-CS455P) is used for mini DV cassette tapes.

### **Digital slow motion/jog**

The slow motion playback images can be reproduced clearly at any of the speeds given below using commands from the external controller or other such device:  $-0.43/-0.3/-0.2/-0.1/-0.03/0/+0.03/+0.1/+0.2/+0.3/+0.43$ .

#### **<Notes>**

- Some noise may occur when the slow motion speed is changed.
- When slow motion playback is used, the image shakes slightly in the vertical direction.

### **Dialy shuttle operation is possible through the external controller**

Shuttle operations enable the tape to be played back with color images at a speed of up to 60 times normal tape speed in either the forward or reverse direction.

### **Time codes**

This unit comes with a built-in time code generator (TCG)/time code reader (TCR). In addition to the internal time code, an external time code input or input signal VITC can be recorded in the machine.

---

---

## Features

(continued)

### **Multi-function input/output interfaces**

- **Analog input/output**

Component (Y, PB, PR) and composite and S1-VIDEO signal input and output connectors are provided.

- **Digital audio input/output**

AES/EBU audio BNC input and output connectors are provided.

- **Serial digital input/output**

Serial digital (SMPTE 259M-C, 272M-C) input/output is possible when the optional component serial interface board (AJ-YA455P) is used.

- **IEEE1394 digital input/output**

Signals can be input and output using the IEEE1394 interface if the digital video interface board (AJ-YAD455P, optional accessory) is used.

- **9-pin (RS-422A)/RS-232C remote**

The standard 9-pin serial (RS-422A) connector or RS-232C connector is used.

### **2-channel high-sound-quality digital audio**

Sound can be edited separately for two channels, and channel mixing capabilities are also available. One channel is provided for the analog cue track.

Information selected from audio CH1 and CH2 can be recorded in the cue track memory. (Set at the set up menu.)

- Cue track input and output connectors are not provided.

### **Automatic editing functions from the external controller**

Both assemble and insert editing can be performed using an external controller (but only when DVCPRO cassettes are used).

### **Menu-driven setup**

The setup settings, which are conducted prior to operating the unit, are performed while viewing the setup menus either on the unit display or TV monitor.

# Controls and their functions

## Front panel

### Counter Display Section

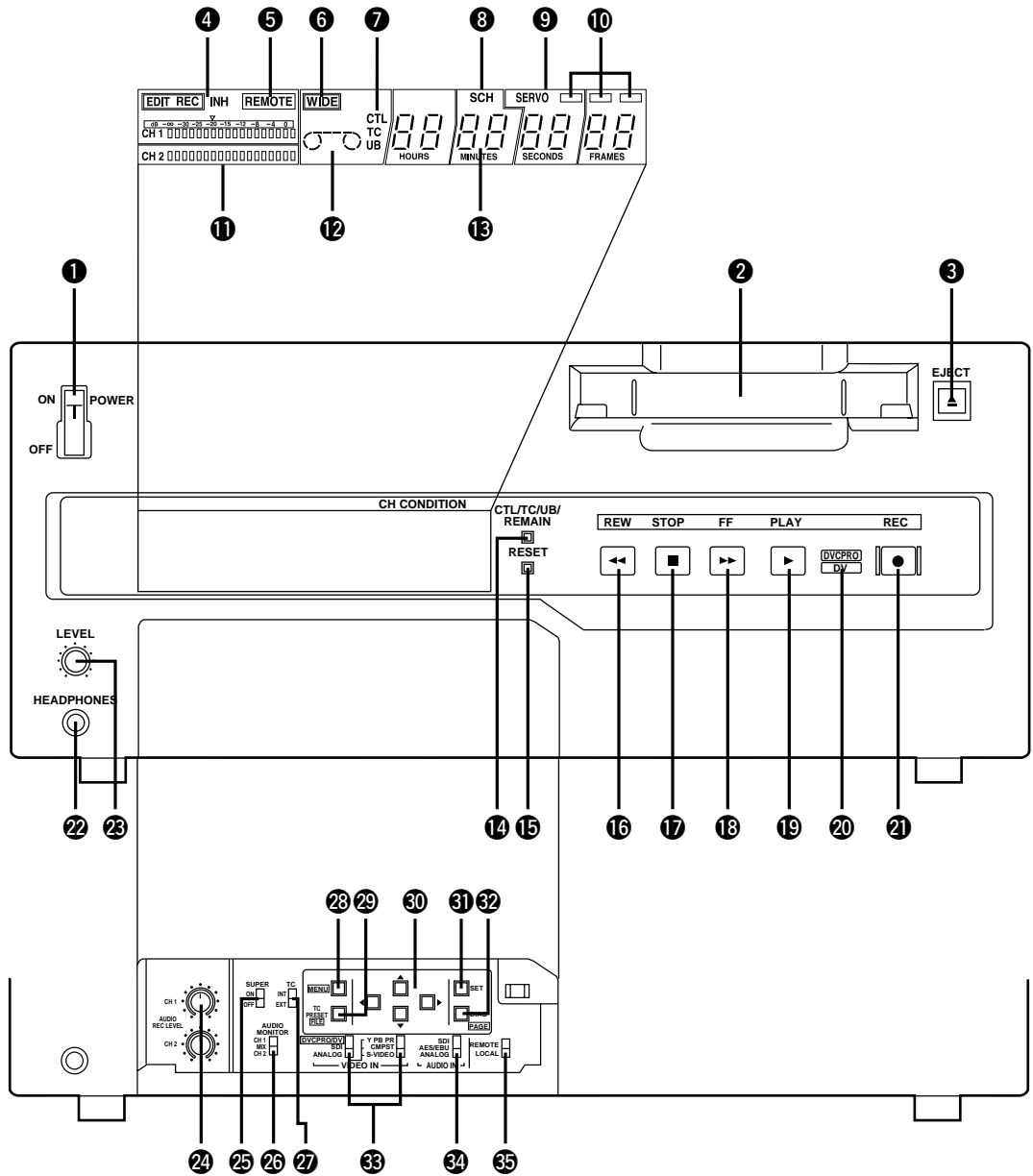

---

---

**① POWER switch**

When the ON side is pressed, the power is switched on, and the counter display lights up.

**② Cassette insertion slot**

**③ EJECT button**

When this is pressed, the tape is unloaded and several seconds later the cassette is automatically ejected. When the counter display indicates "CTL", the display is reset.

**④ EDIT/EDIT REC/REC/REC INH lamps**

**EDIT:** This lights when the editing mode is chosen from the 9P remote control.

**EDIT REC:** This lights when editing from the 9P remote control.

**REC:** This lights during video recording.

**REC INH:** This lights when the accidental erasure prevention mode has been set for the cassette. In this state, neither recording nor editing is possible.

**⑤ REMOTE lamp**

This lights when the REMOTE/LOCAL switch has been set to the REMOTE position.

**⑥ WIDE lamp**

This lights when the unit is in 16:9 wide screen mode.

**⑦ Tape counter type display**

**CTL:** This indicates the tape timer (control signal).

**TC:** This indicates the time code.

**UB:** This indicates the user bit.

**No lighting:** The remaining tape is displayed.

**⑧ SCH lamp**

This lights when the SCH phase of the reference video signal is within the prescribed range.

**⑨ SERVO lamp**

This lights when the drum servo and capstan servo have locked.

**⑩ Channel condition lamps**

One of these lamps lights in accordance with the error rate status. (Green→blue→red)

**Green:** This lights when the error rates for the video and audio playback signals are both acceptable.

**Blue:** This lights when the error rate for the video or audio playback signals has deteriorated.

The playback picture will remain normal even when this lamp lights.

**Red:** This lights when the video or audio signals are subject to rectification or interpolation.

**⑪ Level meters**

These indicate the PCM audio signal CH1/CH2.

The audio signal indicates the input signal levels during recording and EE selection, and the output signal levels during playback.

**⑫ Cassette insertion display lamp**

This lights when a cassette has been inserted into the unit.

**⑬ Counter display**

This displays the TC and CTL count values, on-screen information and other messages.

# Controls and their functions

---

## 14 CTL/TC/UB/REMAIN button

Each time this is pressed, the counter display is switched by one setting in the following sequence: CTL → TC → UB → REMAIN.

“r\*\*\*-\*\*\*” appears when the remaining tape is displayed. The amount of tape remaining is displayed after “r” and the total tape length is displayed after “-”. The display shows “r - ” at EJECT and after a tape is inserted until the remaining tape and total tape length are calculated.

## 15 RESET button

When this is pressed during CTL mode, the counter returns to the 00:00:00:00 display.

During menu setup, initial setting values are restored when the RESET button is pressed.

## 16 REW button\*

The tape is rewound when this is pressed.

The unit goes into shuttle (SHTL) mode at  $-9.5\times$  normal tape speed when this button is pressed together with the PLAY button.

## 17 STOP button

When this is pressed, the tape stops traveling, and if the setup menu No. 111 (STOP EE SEL) is set to TAPE, still pictures can be monitored.

The drum continues to rotate even in the stop mode, and the tape remains in close contact with the drum.

If the stop mode continues for more than a certain period of time, the unit automatically switches to the standby OFF mode in order to protect the tape.

The stop mode is established immediately after a cassette has been inserted into the unit.

## 18 FF button

The tape is fast forwarded when this is pressed.

The unit goes into shuttle (SHTL) mode at  $+9.5\times$  normal tape speed when this button is pressed together with the PLAY button.

## 19 PLAY button

Playback commences when this button is pressed.

Recording commences when the button is pressed together with the REC button.

## 20 Format display

The DVCPRO lamp lights when a DVCPRO cassette has been inserted or when no cassette is inserted. The DV lamp lights when a consumer-use DV cassette has been inserted.

## 21 REC button

Recording commences when this button is pressed together with the PLAY button.

When it is pressed during playback, search, fast forward or rewind, EE mode images and audio signals can be monitored for as long as it is kept depressed.

When it is pressed in the stop mode, EE mode images and sound can be monitored.

When the STOP button is pressed, the original picture and sound are restored.

DVCPRO recording is performed when a DVCPRO cassette is used; DV recording is performed when a consumer-use cassette is used.

## 22 Headphones jack

The sound being recorded, played back or edited can be monitored on stereo headphones when they are connected to this jack.

\* The FF/REW speed can be selected on the setup menu No. 102 (FF. REW MAX), and it is set to the same speed.



---

---

**23 Volume control**

This is used to adjust the headphones volume.

**24 Audio recording level controls\***

These are used to adjust the recording levels of the audio signal CH1/CH2.

**25 SUPER ON/OFF switch**

**ON:** The time code or other display is superimposed onto the signals supplied to the VIDEO OUT 3 connector.

**OFF:** No display is superimposed.

**<Notes>**

- When the AJ-YA455P is used, the superimposed display appears at the VIDEO OUT 3 connector.
- When the SUPER ON/OFF switch is set to ON, the EDH of the SDI OUT 3 connector is not superimposed.

**26 MONITOR SELECT switch**

This is used to select the audio signals output to the monitor channel.

**27 INT/EXT switch**

**INT:** For using the built-in time code generator.

**EXT:** For using the time external code which is input from the time code input connector or the video signal VITC. The selection is set at the setup menu.

**28 MENU button**

When this is pressed, the setup menu appears on the TV monitor using VIDEO OUT 3 connector, and the setup menu No. appears on the display.

When it is pressed again, the setup mode is exited and the original operating mode is restored.

**29 TC PRESET (FILE) button**

The time code setting mode is established by pressing this button. (For details, refer to the time code section on page 39.)

User file can be selected when the cursor buttons (◀, ▶) are used during the setup menu mode. (For details, see setup menu items on page 16.)

**30 Cursor buttons (◀, ▶, ▲, ▼)**

These are used when setting time codes and settings at menu setup.

◀, ▶: These change the flashing digit in the time code indicators.

Each time they are pressed, the flashing indicator moves incrementally to the left or right.

◀ increments to the left; ▶ increments to the right.

▲, ▼: These change the flashing digit in the time code indicators.

Each time they are pressed, the indicated value increments and decrements.

▲ decrements the value; ▼ increments the value.

The flashing digit changes continuously when the button is continuously pressed.

For details about operation during setup menu mode, see setup menu items (page 15).

**31 SET button**

The time code is set or the data selected for the setup menu settings are entered by pressing this button.

After the data has been entered, the setup mode is exited, and operation returns to the original mode.

\* The recording level of the audio signals cannot be adjusted when DVCPRO/DV has been selected by the VIDEO INPUT switch 33.

# Controls and their functions

---

## 32 DIAG button

When this is pressed, VTR information is displayed. When it is pressed again, the original display is restored.

There are two types of VTR information: "HOURS METER" information and "WARNING" information. Switching between these types is enabled by pressing the cursor buttons (◀, ▶).

Indicated on the "HOUR METER" screen are the power-on time, drum rotation time, tape travel time, loading count, etc.

Indicated on the "WARNING" screen are the warnings.

- The status information on the IEEE1394 interface can be referenced when the AJ-YAD455P digital video interface board is used.

## 33 VIDEO INPUT switch

This switches the video input signal.

**DVCPRO/DV:** Set to this position when recording digital video interface signals (IEEE1394). (At the same time, audio input signals from IEEE1394 will also be recorded.)\*<sup>1</sup>

**SDI:** For selecting serial component digital video signal (SMPTE 259M-C) recording.\*<sup>2</sup>

**ANALOG:** For selecting analog video signal recording.  
Select the analog video signal as follows to correspond with the input signal.

**Y Pb Pr:** For recording an analog component video signal.

**CMPST:** For recording an analog composite video signal.

**S-VIDEO:** For recording a S-VIDEO signal.

\*1: The AJ-YAD455P digital video interface board (optional accessory) is required for this.

\*2: The AJ-YA455P serial interface board (optional accessory) is necessary.

## 34 AUDIO INPUT switch

This switches the audio input signal.

**SDI:** For selecting serial digital audio signal (SMPTE 272M-A) recording.\*

**AES/EBU:** For recording a digital audio signal.

**ANALOG:** For recording an analog audio signal.

\* The AJ-YA455P serial interface board (optional accessory) is required for this.

### <Notes>

- The DVCPRO/DV format will also apply to the audio input signals when DVCPRO/DV has been selected by the VIDEO INPUT switch 33.
- When SD or AES/EBU is to be selected, the reference video signal must be input, and the audio data synchronized with the REF VIDEO signal must be supplied.

## 35 REMOTE/LOCAL switch

This is set to control the unit from an external component using the REMOTE, RS-232C or digital video interface (IEEE1394) connector.

**REMOTE:** Set here to control the unit by a component connected to the unit using the 9-pin REMOTE, RS-232C or digital video interface (IEEE1394) connector.

**LOCAL:** Set here to control the unit using the switches and controls on the unit's control panel.

# Connector area

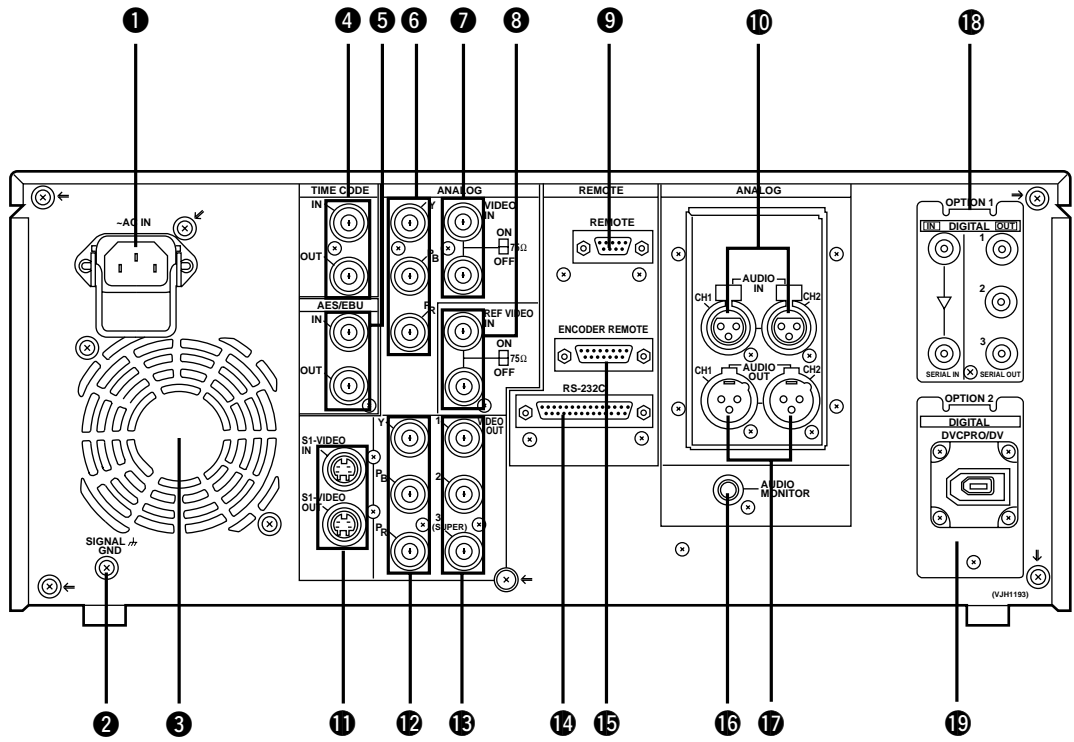

# Controls and their functions

---

## <Connector area>

**① AC IN socket**

**② SIGNAL GND terminal**

This is connected to the signal ground terminal on the component connected to the unit in order to reduce the noise. It is not a safety ground.

**③ Fan motor**

This motor drives the fan to cool down the unit.

**④ TIME CODE IN/OUT connectors**

These are the time code input and output connectors.

**⑤ DIGITAL AUDIO IN/OUT connectors**

These are the input and output connectors for the digital audio signals complying with the AES/EBU standard.

**⑥ ANALOG COMPONENT VIDEO IN connectors**

These are the analog component video signal input connectors.

**⑦ ANALOG COMPOSITE VIDEO IN connectors and 75Ω termination switch**

These are the analog composite video signal input connectors.

The two connectors are connected by a loop-through configuration. For termination, set the switch to ON.

**⑧ REF VIDEO IN connectors and 75Ω termination switch**

These are the reference video signal input connectors.

For termination, set the switch to ON.

**⑨ REMOTE connector (RS-422A connector)**

The unit's operations can be controlled from an external component by connecting an external controller to the unit using this connector.

**⑩ ANALOG AUDIO CH1/CH2 connectors**

These are the analog audio CH1 and CH2 input connectors.

**⑪ S1-VIDEO IN/OUT connectors**

These are the S1-VIDEO signal input and output connectors.

**⑫ ANALOG COMPONENT VIDEO OUT connectors**

These are the analog component video signal output connectors.

**⑬ ANALOG COMPOSITE VIDEO OUT connectors**

These are the analog composite video signal output connector. Video signals with a superimposed display can be output from the VIDEO OUT 3 connector. Whether a display is to be superimposed onto the signals is selected using the SUPER ON/OFF switch.

**⑭ RS-232C connector**

The unit's operations can be controlled by a personal computer or other component which is connected to the unit using this connector.

**⑮ ENCODER REMOTE connector**

An external encoder controller is connected here to adjust the video output signal settings externally.

---

---

**16 MONITOR OUT connector**

The PCM audio CH1 and/or CH2 signals (or playback signals from the CUE track) are output to this connector. PCM audio signals are output in the PLAY mode and in the  $-0.43\times$  ( $-0.5\times$ ) to  $+1\times$  speed range; at all other times, the CUE signals are automatically output.

**<Notes>**

- The speed in parentheses given for the speed range above applies when a DV or DVCAM cassette is used.
- Either CH1, CH2 or mixed (CH1+CH2) PCM audio signals are output depending on the position selected by the AUDIO MONITOR SELECT switch.

**17 ANALOG AUDIO OUT connectors**

These are the analog audio CH1 and CH2 output connectors.

**18 SERIAL DIGITAL COMPONENT AUDIO VIDEO IN/OUT connectors**

**(The AJ-YA455P, an optional accessory, is required.)**

These are the input and output connectors for the digital component audio and video signals complying with the SMPTE259M-C or 272M-A standard.

**19 DIGITAL VIDEO INTERFACE (IEEE1394) IN/OUT connector**

**(The AJ-YAD455P, an optional accessory, is required.)**

This is the IEEE1394 interface input/output connector.

Type	Description
<b>Consumer cassette (Standard DV cassette) (Mini DV cassette)</b>	Use the cassette adapter (AJ-CS455P) for the mini DV cassette tapes. Bear in mind that long-playing mini DV cassette tapes (standard mode: 80 minutes/LP mode: 120 minutes) cannot be used. <u>Also bear in mind that recordings cannot be made on a tape when the AJ-CS750 cassette adapter is used.</u> <b>Use of Panasonic consumer DV cassette tapes is recommended.</b> Remember to refrain from inserting a mini DV cassette without using the cassette adapter since malfunctioning or problems may result.
<b>M cassette</b>	Recording/playback tape with a maximum capacity of 66 minutes. (AJ-P12MP, AJ-P24MP, AJ-P33MP, AJ-P46MP, AJ-P66MP)
<b>L cassette</b>	Recording/playback tape with a maximum capacity of 184 minutes. (AJ-P34LP, AJ-P66LP, AJ-P94LP, AJ-P126LP, AJ-5P92LP)

Align the cassette with the center of the insertion slot, and gently push it inside. The cassette tape is automatically loaded.

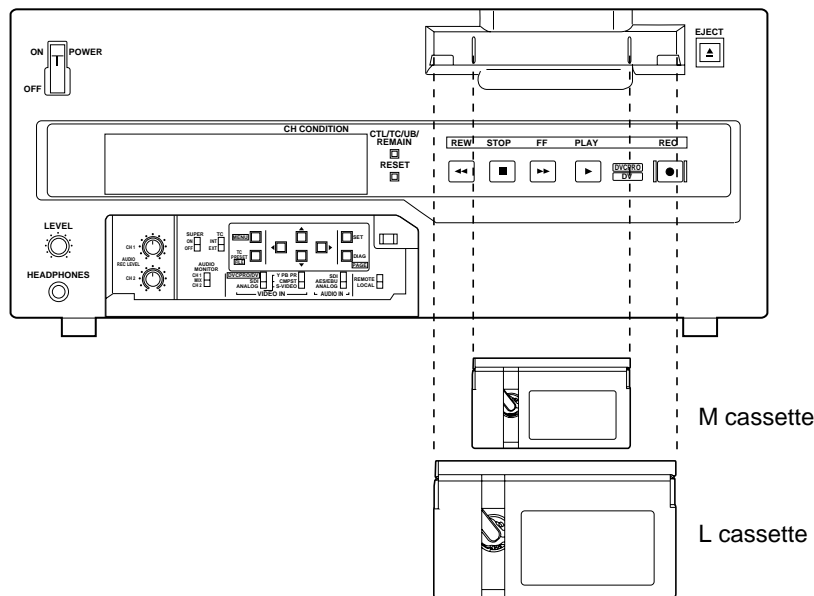

### <Cautions when playing back consumer DV tapes and DVCAM tapes>

- Consumer DV tapes which have been recorded in the LP mode cannot be played back.
- When materials which have been recorded on consumer DV tapes or DVCAM tapes are to be edited, record them onto a DVCPRO tape or tape of any other broadcasting VTR for use.
- The maximum transport speed for consumer DV tapes and DVCAM tapes is 32 times the normal tape speed.
- The video images may be disturbed during slow motion playback of consumer-use tapes.
- From the viewpoint of protecting the tape, minimize repeated cue-up at the same location on a consumer-use tape.
- The maximum STILL TIMER time is set to 20 seconds when a consumer-use tape is used.
- The sampling rate of the audio signals recorded on a consumer-use tape is 48 kHz. When the AJ-YAD455P digital video interface board is used, audio signals can be recorded at a rate of 44.1 kHz or 32 kHz on a consumer-use tape only when DVCPRO/DV signals are input.
- During recording on a consumer-use tape, scenes can be recorded with continuity between frames by exercising control from the controller or personal computer (when the AJ-YAD455P digital video interface board is used) which has the REC/PAUSE command. However, in this case, the video and sound for the one frame before and after the continuity point may be disturbed.

# Setup (default settings)

The unit's major settings are performed by making selections on menus. The setting menus appear on the TV monitor when the TV monitor and VIDEO OUT 3 connector in the unit's connector area are hooked up. The menus can be output to the SDI OUT 3 connector as well when the AJ-YA455P component serial interface board is used.

## Changing the settings

- 1** Press the MENU button.  
The setup menu appears on the TV monitor and setup menu No. appears on the counter display. (If the setup has already been performed, the screen showing the changes made last will appear.)
- 2** Press the cursor buttons (▲, ▼) and select the item to be set.  
The cursor (\*) on the menu screen moves and the item No. on the display flashes.
  - When the ▼ button is pressed, the item No. is incremented for 001 → 002 → 003 → 004 → and so on; when the ▲ button is pressed, the item No. is decremented.
- 3** Press the cursor buttons (◀, ▶) at the position where the change is to be made.  
The menu screen and display setting No. now flashes.  
When the ▶ button is pressed, the setting No. is incremented; when the ◀ button is pressed, it is decremented.
- 4** Repeat steps 2 and 3 to change other items.
- 5** Press the SET button.  
The changes are now stored in the memory.
  - To return the items to the settings established before the changes were made, press the MENU button without pressing the SET button.

To return the setup settings to the factory (initial) settings, press the RESET button while the menu is displayed.

### The following message is displayed.

SETUP-MENU INIT SET  
YES<PLAY>/NO<STOP>

When the PLAY button is pressed, the factory settings are restored.

**<Notes>**

- When the RESET button is pressed to return to the factory settings, the factory settings are restored only for the user file currently being used and other user files are not affected.
- The changed SYSTEM menu contents are stored in the memory even if the MENU button is pressed.

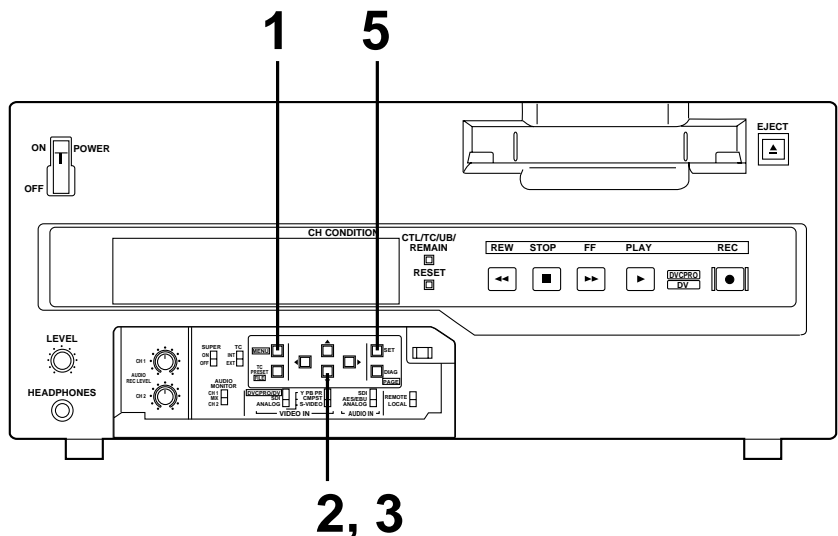



# Setup menus

---

This unit can store up to 5 user files (user 1 to user 5) containing different menu settings, and these files can be selected and used.

## Changing the file

- 1** Press the MENU button.
- 2** Hold down the FILE button and press the cursor button  to switch to the next user file.  
Hold down the FILE button and press the cursor button  to switch to the previous user file.

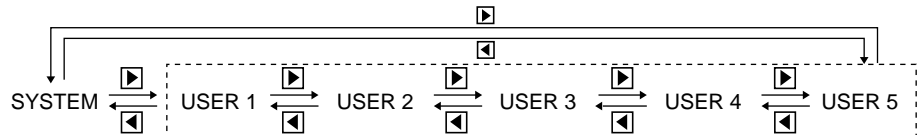

### USER FILE

Each user file contains the following items.

- BASIC
- OPERATION
- INTERFACE
- EDIT
- TAPE PROTECT
- TIME CODE
- VIDEO
- AUDIO
- MENU

- 3** Repeat the operation in step 2 to select the user file to be used and press the SET button. The user file is changed and stored in the memory.

### <Note>

SYSTEM menu items are not included in user files 1 to 5.

Therefore, after selecting the user file, switch to the SYSTEM file and set the SYSTEM menu items.



---

---

Lock mode can be set to protect the settings in the system files and user files (USER2 – USER5). Settings can no longer be changed when this mode is set.

To set and release the lock mode for the system files and user files use setup item No. 30 (MENU LOCK) and setup menu item No. A03 (MENU LOCK), respectively.

### Setting and releasing the lock mode.

- 1** Press the MENU button.
- 2** While holding down the FILE button, press the ◀ or ▶ button, and select the file for which the lock mode is to be set or released.
- 3** Press the ▲ or ▼ button and move the cursor (\*) on the menu screen to setup item No. 30 (MENU LOCK) or setup menu item No. A03 (MENU LOCK) for the system or user file.
- 4** Press the ◀ or ▶ button, and select lock mode setting or release.  
**To set the lock:** Select the 0001 (ON) setting.  
**To release the lock:** Select the 0000 (OFF) setting.

When the lock has been set, “LOCKED” flashes on the menu screen. In addition, the counter display stops flashing and lights.

SETUP-MENU	LOCKED
<USER2>	NO.000 - 0005
*000 P-ROLL TIME	5s
001 CHARA H-POS	5
002 CHARA V-POS	23
003 DISPLAY SEL	T&STA
004 LOCAL ENA	ST&EJ
005 TAPE TIMER	±12h
006 SUPER	ON
007 CHARA TYPE	WHITE
101 SHTL MAX	X32

- 5** Press the SET button. The setting is now stored in the memory.

#### <Notes>

- The lock mode cannot be set for the USER1 file settings.
- Even if the RESET button is pressed, the files which has been set to the lock mode cannot be reset to the factory settings.

# Setup menus

The contents of the USER2 – USER5 files can be copied (loaded) into the USER1 file. In addition, the contents of the USER1 file can be copied (saved) to the USER2 – USER5 files.

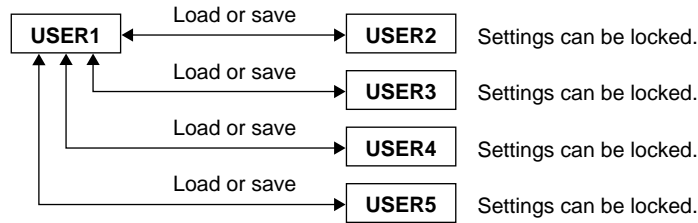

## Loading a user file

- 1 Press the MENU button.
- 2 While holding down the FILE button, press the ◀ or ▶ button, and select USER1.
- 3 Press the ▲ or ▼ button and move the cursor (\*) on the menu screen to setup item No. A00 (LOAD).

```

SETUP-MENU  MENU
<USER1>    NO.A00 - 0000
 725 CUE SLOW      STEP
*A00 LOAD          USER2
 A01 SAVE          USER2
 A02 P.ON LOAD     OFF
 END
  
```

- 4 Press the ◀ or ▶ button and select the user file whose contents are to be loaded into USER1.
- 5 Press the SET button. The following messages appear on the menu screen and counter display.

Menu screen

```

SETUP-MENU LOAD

USER2 → USER1 OK?
YES<PLAY>/NO<STOP>
  
```

Counter display

```

L U2 -U1
  
```

The user file number selected in step 4 is displayed in the shaded area.

- 6 Press the PLAY button. The settings of the user file selected in step 4 are loaded, and the USER1 menu display appears. When the STOP button is pressed, the USER1 menu display appears while the settings remain unchanged.
- 7 Press the ▲ or ▼ button and move the cursor (\*) on the menu screen to any setup item except No. A00 (LOAD) and No. A01 (SAVE).
- 8 Press the SET button. The USER1 settings are now stored in the memory. If the USER1 settings are not going to be stored in the memory, do not press the SET button but press the MENU button.

---

---

## Saving a user file

- 1 Press the MENU button.
- 2 While holding down the FILE button, press the ◀ or ▶ button, and select USER1.
- 3 Press the ▲ or ▼ button and move the cursor (\*) on the menu screen to setup item No. A01 (SAVE).

```
SETUP-MENU  MENU
<USER1>     NO.A00 - 0000
 723 DV PB ATT      OFF
A00 LOAD           USER2
*A01 SAVE          USER2
A02 P.ON LOAD      OFF
END
```

- 4 Press the ◀ or ▶ button and select the user file into which the USER1 contents are to be saved. User files which have been set to the lock mode are not displayed. When all the user files have been set to the lock mode, the “LOCKED” display appears and the contents cannot be saved.
- 5 Press the SET button. The following messages appear on the menu screen and counter display.

Menu screen

```
SETUP-MENU SAVE

USER1 → USER2 OK?
YES<PLAY>/NO<STOP>
```

Counter display

```
S U1 -U2
```

The user file number selected in step 4 is displayed in the shaded area.

- 6 Press the PLAY button. The contents of the USER1 file are saved in the user file which was selected in step 4 and stored in the memory. When the STOP button is pressed, the USER1 menu display appears while the settings remain unchanged.
- 7 Press the ▲ or ▼ button and move the cursor (\*) on the menu screen to any setup item except No. A00 (LOAD) and No. A01 (SAVE).
- 8 Press the SET button. The USER1 settings are now stored in the memory. If the USER1 settings are not going to be stored in the memory, do not press the SET button but press the MENU button.

## Automatic loading of user file when the power is turned on

When the user file to be loaded is selected in advance using setup menu item No. A02 (P.ON LOAD), it can be automatically loaded into USER1 when the power is turned on.

# Setup menus

## SYSTEM menu

### <SYSTEM>

Item		Setting		Description
No.	Superimposed display	No.	Superimposed display	
00	SYS SC COAR.	<u>0000</u> 0001 0002 0003	<u>0</u> 90 180 270	System phase rough adjustment: 90° units <b>&lt;Note&gt;</b> If setting operation is performed, the setting value does not return to factory (default) setting.
01	SYS SC FINE	0000 ⋮ <u>0127</u> ⋮ 0255	-127 ⋮ <u>0</u> ⋮ 128	System phase fine adjustment: Variable range ±45° or more -: advanced +: delayed <b>&lt;Note&gt;</b> If setting operation is performed, the setting value does not return to factory (default) setting.
02	SYS H	0000 ⋮ <u>0127</u> ⋮ 0255	-127 ⋮ <u>0</u> ⋮ 128	System phase adjustment: SC period increments, ±15 μs variable range -: Advanced +: Delayed <b>&lt;Note&gt;</b> If setting operation is performed, the setting value does not return to factory (default) setting.
03	ENCODER SEL	<u>0000</u> 0001	<u>OFF</u> ON	For selecting whether the ENCODER REMOTE connector is to function or not. 0: Does not functions. 1: Functions.
05	SCH COARSE	<u>0000</u> 0001 0002 0003	<u>0</u> 90 180 270	For coarsely adjusting the SCH phase: 90-degree increments (The SC phase is varied but the H phase remains unchanged.)
06	SCH FINE	0000 ⋮ <u>0032</u> ⋮ 0064	-32 ⋮ <u>0</u> ⋮ 32	For finely adjusting the SCH phase: Variable range from -45° to +45° (The SC phase is varied but the H phase remains unchanged.)
10	AV PHASE	0000 ⋮ <u>0128</u> ⋮ 0255	-128 ⋮ <u>0</u> ⋮ 127	This adjusts the audio output phase with respect to the video output: 20.8 μs steps -: The audio output phase is advanced with respect to the video output. +: The audio output phase is delayed with respect to the video output.
15	VIDEO LEVEL	0000 ⋮ <u>0127</u> ⋮ 0255	-127 ⋮ <u>0</u> ⋮ 128	For setting the video level. The maximum amount by which the level can be varied is from -3 to +3 dB.
16	SET UP LEVEL	0000 ⋮ <u>0127</u> ⋮ 0255	-127 ⋮ <u>0</u> ⋮ 128	For setting the setup amount. The maximum amount by which the setup can be varied is 14 IRE.
17	HUE	0000 ⋮ <u>0128</u> ⋮ 0255	-128 ⋮ <u>0</u> ⋮ 127	For setting the hue. The maximum amount by which the hue can be varied is from -30° to +30°.

The underline on the setting item denotes the initial setting.

## SYSTEM menu

### <SYSTEM> (continued)

Item		Setting		Description
No.	Superimposed display	No.	Superimposed display	
18	CHROMA LEVEL	0000 ⋮ <u>0127</u> ⋮ 0255	-127 ⋮ _____0 ⋮ 128	For setting the chroma level. The maximum amount by which the level can be varied is from -3 to +3 dB.
21	SYS H OFFSET	0000 0001 0002 <u>0003</u> 0004 0005 0006	-3 -2 -1 _____0 4 5 6	For adjusting the system phase offset: 4.48 μs steps 0: -13.4 μs 1: -8.96 μs 2: -4.48 μs 3: 0 4: +4.48 μs 5: +8.96 μs 6: +13.4 μs <b>&lt;Notes&gt;</b> • The setting remains unchanged even when the factory setting operation is performed. • When this menu item is used together with SYSTEM menu item No. 02 (SYS H) setting, the adjustment is limited to a range from -15 to +15 μs.
22	SYS SC/H	<u>0000</u> 0001	<u>REMOTE</u> LOCAL	For setting whether the system phase is to be adjusted by the unit or from the external encoder remote connector. 0: The system phase is adjusted from the external encoder remote connector. 1: The system phase is adjusted by the unit. <b>&lt;Notes&gt;</b> • This setting remains unaffected when OFF is selected as the SYSTEM menu item No. 3 (ENCODER SEL) setting. • The range for the system phase adjustment using the encoder remote connector is -3 to +3 μs. When this menu item is used together with SYSTEM menu item No. 021 (SYS H OFFSET) setting, adjustment can be made from -15 to +15 μs.
30	MENU LOCK	<u>0000</u> 0001	_____OFF ON	This selects whether the system file lock mode is to be engaged or released. 0: The lock is released (file data can be changed). 1: The lock is engaged (file data cannot be changed).

The underline on the setting item denotes the initial setting.

### Video output signal adjustments

The SYSTEM menu item No. 03 (ENCODER SEL) and No. 22 (SYS SC/H) settings are used to make the video output signal adjustments. The table below shows the control matrix for these adjustments.

Setting		Adjustment item	
SYSTEM menu item 03: ENCODER SEL	SYSTEM menu item 22: SYS SC/H	SYSTEM menu item 00: SYS SC COAR. 01: SYS SC FINE	VIDEO LEVEL CHROMA LEVEL SET UP HUE
OFF	LOCAL REMOTE	Unit	Unit (SYSTEM menu)
ON	LOCAL REMOTE	Unit External encoder remote	External encoder remote

# Setup menus

## USER menu

### <BASIC>

Item		Setting		Description
No.	Superimposed display	No.	Superimposed display	
000	P-ROLL TIME	0000 ⋮ <u>0005</u> ⋮ 0015	0S ⋮ <u>5S</u> ⋮ 15S	This sets the preroll time which can be set from 0 to 15 seconds in 1-second increments. <b>&lt;Note&gt;</b> The unit will not operate if the preroll time is set to 0 seconds when the unit is set to automatic editing (PREVIEW, AUTO EDIT COMMAND) from an external controller.
001	CHARA H-POS	0000 ⋮ <u>0004</u> ⋮ 0016	0 ⋮ <u>4</u> ⋮ 16	This sets the position of the characters on the horizontal plane for the time code and other super displays output to the VIDEO OUT 3/SERIAL OUT 3* connector. <b>&lt;Note&gt;</b> When setting this item, the DISPLAY SEL status is output to VIDEO OUT 3/SERIAL OUT 3* even if SUPER OFF has been set. However, when the menu is exited, operation complies with the SUPER OFF/ON setting. Also, CHARA TYPE is output to VIDEO OUT 3/SERIAL OUT 3* according to the status set in the menu.
002	CHARA V-POS	0000 ⋮ <u>0018</u> ⋮ 0022	0 ⋮ <u>18</u> ⋮ 22	This sets the position of the characters on the vertical plane for the time code and other super displays output to the VIDEO OUT 3/SERIAL OUT 3* connector. <b>&lt;Notes&gt;</b> 1. When setting this item, the DISPLAY SEL status is output to VIDEO OUT 3/SERIAL OUT 3* even if SUPER OFF has been set. However, when the menu is exited, operation complies with the SUPER OFF/ON setting. Also, CHARA TYPE is output to VIDEO OUT 3/SERIAL OUT 3* according to the status set in the menu. 2. When the DISPLAY SEL setting causes characters to extend beyond the edges of the screen, the setting value is changed so that the characters are automatically displayed in a position on the screen.
003	DISPLAY SEL	0000 <u>0001</u> 0002 0003 0004 0005 0006	TIME T&STA T&S&M T&RT T&YMD T&MDY T&DMY	For selecting the time code and/or other information which is to be shown on the superimposed display at the VIDEO OUT 3/SERIAL OUT 3* connector. 0: Time only 1: Time and operation mode 2: Time, operation mode and mode 3: Time and REC TIME 4: Time and REC DATE (year/month/day) 5: Time and REC DATE (month/day/year) 6: Time and REC DATE (day/month/year) <b>&lt;Notes&gt;</b> 1. The mode display is DVCPRO during DVCPRO playback, DV during DV playback, and DVCAM during DVCAM playback. 2. When 2 (T&S&M) is set, an error message will appear when a warning or error has occurred. 3. REC TIME and REC DATE are displayed during DV or DVCAM playback only. The operation mode is displayed during DVCPRO playback.
004	LOCAL ENA	0000 <u>0001</u> 0002	DIS <u>ST&amp;EJ</u> ENA	This selects the buttons which can be operated on the front panel when the REMOTE/LOCAL switch has been set to REMOTE. 0: No buttons can be operated. 1: Only the STOP and EJECT buttons can be operated. 2: All buttons can be operated.

\* The SERIAL OUT 3 connector functions only when the AJ-YA455P serial interface board (optional accessory) is used.

The underline on the setting item denotes the initial setting.

## USER menu

### <BASIC> (continued)

Item		Setting		Description
No.	Superimposed display	No.	Superimposed display	
005	TAPE TIMER	<u>0000</u> 0001	<u>±12h</u> 24h	This selects the 12 or 24 hour display for the CTL counter. 0: 12 hour display 1: 24 hour display
007	CHARA TYPE	<u>0000</u> 0001	<u>WHITE</u> W/OUT	This selects the display type for the super display output to the VIDEO OUT 3/SERIAL OUT 3* connector as well as for displays such as the setting menu, etc. 0: White characters against a black background. 1: White characters with a black border.
008	REMAIN SEL	<u>0000</u> <u>0001</u> 0002 0003	OFF <u>2L</u> 1L R/TTL	For selecting whether to display the remaining tape time and total tape length as the superimposed display at the VIDEO OUT 3/SERIAL OUT 3* connector. 0: No display appears. 1: Remaining tape time is displayed on the second line. 2: Remaining tape time is displayed on the first line. 3: Remaining tape time is displayed on the first line and the total tape length on the second line. <b>&lt;Notes&gt;</b> • When setting 1 (2L) has been selected, the display does not appear if 0 (TIME) has been selected for the setup menu No. 003 (DISPLAY SEL) setting. • When setting 3 (R/TTL) has been selected, the total tape length will not appear if 0 (TIME) has been selected for the setup menu No. 003 (DISPLAY SEL) setting.

\* The SERIAL OUT 3 connector functions only when the AJ-YA455P serial interface board (optional accessory) is used.

The underline on the setting item denotes the initial setting.

# Setup menus

## USER menu

### <OPERATION>

Item		Setting		Description
No.	Superimposed display	No.	Superimposed display	
101	SHTL MAX	0000 <u>0001</u> 0002	×16 <u>×32</u> ×60	This sets the maximum speed for shuttle operations. 0: 16× normal speed 1: 32× normal speed 2: 60× normal speed <b>&lt;Note&gt;</b> When a DV or DVCAM cassette is used, the 32× speed will be set even if “×60” has been selected as this item’s setting.
102	FF. REW MAX	0000 <u>0001</u> 0002	×32 <u>×60</u> ×100	This sets the maximum speed for FF and REW operations. 0: 32× normal speed 1: 60× normal speed 2: 100× normal speed <b>&lt;Note&gt;</b> When a DV or DVCAM cassette is used, the 32× speed will be set regardless of what has been selected as this item’s setting.
103	AUDIO MUTE	<u>0000</u> 0001	<u>OFF</u> ON	This sets the status until the audio signal is output when operation switches from the stop or search modes to the play mode. 0: The time until the audio is output is shortened. 1: The audio is output after the status stabilizes. <b>&lt;Note&gt;</b> When set to 0 (OFF), the sound in the initially output part is incomplete. Therefore, this setting is not recommended for broadcasts.
104	REF ALARM	0000 <u>0001</u>	OFF <u>ON</u>	This selects whether to warn the operator when the REF.VIDEO signal has not been connected. 0: Warning is not given. 1: Warning is given by the flashing STOP lamp.
106	PLAY DELAY	<u>0000</u> ⋮ 0015	<u>0</u> ⋮ 15	This set the play delay time in frame increments.
107	CAP.LOCK	<u>0000</u> 0001	<u>2F</u> 4F	This selects the capstan lock mode. 0: 2F mode 1: 4F mode
109	EJECT EE SEL	<u>0000</u> 0001 0002	<u>EE</u> BLACK GRAY	For selecting the video and audio output status when the tape is ejected. 0: EE mode 1: Video blackens, audio mutes. 2: The images appear in gray, and the sound is muted.
110	F/R EE SEL	<u>0000</u> 0001	<u>EE</u> TAPE	This selects whether EE mode or playback mode is to be used during FF/REW operations. 0: EE mode 1: Playback mode
111	STOP EE SEL	<u>0000</u> 0001	<u>EE</u> TAPE	This selects whether EE mode or playback mode is to be used during stop mode. 0: EE mode 1: Playback mode <b>&lt;Note&gt;</b> This setting is complied with even in the standby OFF mode. However, the images will appear in gray when “TAPE” has been selected.
112	AUTO REW	<u>0000</u> 0001	<u>OFF</u> ON	This selects whether to rewind the tape automatically to the tape start when the tape end is detected. 0: The tape stops at the tape end. 1: The tape is rewound to the tape start.

The underline on the setting item denotes the initial setting.



## USER menu

### <OPERATION> (continued)

Item		Setting		Description
No.	Superimposed display	No.	Superimposed display	
113	MEMORY STOP	<u>0000</u> 0001	<u>OFF</u> ON	This selects whether the VTR is to stop automatically when the counter value reaches "0" during a fast forwarding or rewinding operation in the CTL mode. 0: The VTR does not stop. 1: The VTR stops automatically. <b>&lt;Notes&gt;</b> 1. The stop mode concerned is either the stop or the still-picture mode depending on the setup menu No. 313 (AFTER CUE-UP) setting. 2. When both the AUTO REW function and MEMORY function have been selected at the same time, the AUTO REW function takes precedence.
114	REC INHIBIT	<u>0000</u> 0001	<u>OFF</u> ON	This selects whether to allow (enable) or prohibit (disable) the recording of signals on the cassette tape. 0: Signals can be recorded on the cassette tape when the cassette's accidental erasure prevention mechanism is set to the recording enable position. 1: Recording on the cassette tape is prohibited. In this case, the REC INH lamp on the front panel lights.
120	REC INH LAMP	<u>0000</u> 0001	<u>LIGHT</u> FLASH	For selecting whether the REC INHIBIT lamp is to flash or light when the cassette has been set to the accidental erasure prevention status. 0: The lamp lights. 1: The lamp flashes. <b>&lt;Note&gt;</b> When ON has been selected as the setup menu item No. 114 (REC INHIBIT) setting, the REC INHIBIT lamp will light all the time regardless of what has been selected as this item's setting.
121	EJECT SW INH	<u>0000</u> 0001	<u>REC</u> OFF	For selecting whether to enable or disable the operation of the front panel's EJECT button. 0: The button's operation is disabled in the recording mode. 1: The button's operation is enabled in all modes.

The underline on the setting item denotes the initial setting.

# Setup menus

## USER menu

### <INTERFACE>

Item		Setting		Description
No.	Superimposed display	No.	Superimposed display	
201	9P SEL	<u>0000</u> 0001	OFF ON	This selects whether the 9-Pin connector functions when the REMOTE/LOCAL switch has been set to REMOTE. 0: Do not function 1: Function
202	ID SEL	<u>0000</u> 0001 0002	OTHER DVCPRO ORIG	This selects the ID information which is returned to the controller. 0: 20 25H 1: DVCPRO's, own ID is returned (F0 33H). 2: The unit's own ID (A0 3CH) is returned. <b>&lt;Note&gt;</b> Set "ORIG" only when the unit is connected with a Panasonic controller (such as the AJ-A900, optional accessory).
204	RS232C SEL	<u>0000</u> 0001	OFF ON	These settings are for selecting whether the RS-232C connector is to function when the REMOTE/LOCAL switch is set to REMOTE. 0: Connector does not function. 1: Connector functions.
205	BAUD RATE	0000 0001 0002 0003 0004 <u>0005</u>	300 600 1200 2400 4800 9600	These settings are for selecting the RS-232C communication speed (baud rate).
206	DATA LENGTH	0000 <u>0001</u>	7 8	These settings are for selecting the RS-232C data length. (Unit: bit)
207	STOP BIT	<u>0000</u> 0001	1 2	These settings are for selecting the RS-232C stop bit length. (Unit: bit)
208	PARITY	<u>0000</u> 0001 0002	NON ODD EVEN	These settings are for selecting the none, odd or even for the RS-232C parity bit. 0: Parity bit is not used. 1: An odd number of bits is used for the parity system. 2: An even number of bits is used for the parity system.
209	RETURN ACK	0000 <u>0001</u>	OFF ON	These settings are for selecting whether the ACK code is to be returned when a command is received from RS-232C. 0: ACK code is not returned. 1: ACK code is returned.

The underline on the setting item denotes the initial setting.

## USER menu

### <EDIT>

Item		Setting		Description
No.	Superimposed display	No.	Superimposed display	
303	STD/ NON-STD	<u>0000</u> 0001 0002	<u>  </u> AUTO STD N-STD	This selects STD or NON-STD in accordance with the composite input signal. 0: Standard/non-standard signals are automatically identified and processed. 1: Standard signals are processed. (Forced STD) 2: Non-standard signals are processed. (Forced NON-STD)
304	SERVO REF	<u>0000</u> 0001	<u>  </u> AUTO EXT	This selects the video signal processing. 0: Servo is synchronized with the input signal during recording and editing, or with the REF signal during playback. 1: Servo is synchronized at all times with the REF signal.
305	EDIT RPLCE1	0000 <u>0001</u> 0002 0003	N-DEF <u>  </u> CH1 CH2 CH1+2	This sets the channel assignments for the controller's analog audio preset when editing the digital audio of the VTR using a controller which does not have a digital audio edit preset control function. This selects the channel concerned when the VTR CH1 edit preset is set in compliance with the ON or OFF presetting for the analog audio signals designated by the controller. 0: Not set. 1: Compliance with analog CH1 edit preset. 2: Compliance with analog CH2 edit preset. 3: Compliance with either analog CH1 or CH2 edit preset.
306	EDIT RPLCE2	0000 0001 <u>0002</u> 0003	N-DEF CH1 <u>  </u> CH2 CH1+2	This sets the channel assignments for the controller's analog audio preset when editing the digital audio of the VTR using a controller which does not have a digital audio edit preset control function. This selects the channel concerned when the VTR CH2 edit preset is set in compliance with the ON or OFF presetting for the analog audio signals designated by the controller. 0: Not set. 1: Compliance with analog CH1 edit preset. 2: Compliance with analog CH2 edit preset. 3: Compliance with either analog CH1 or CH2 edit preset.
307	EDIT RPLCEC	0000 0001 0002 0003	<u>  </u> N-DEF CH1 CH2 CH1+2	This sets the channel assignments for the controller's analog audio preset when editing the digital audio of the VTR using a controller which does not have a digital audio edit preset control function. This selects the channel concerned when the VTR CUE edit preset is set in compliance with the ON or OFF presetting for the analog audio signals designated by the editor or controller. 0: Not set. 1: Compliance with analog CH1 edit preset. 2: Compliance with analog CH2 edit preset. 3: Compliance with either analog CH1 or CH2 edit preset.
309	AUD EDIT IN	0000 <u>0001</u>	CUT <u>  </u> FADE	This selects the connection method for the digital audio edit IN point. 0: Cut processing 1: V Fade processing
310	AUD EDIT OUT	0000 <u>0001</u>	CUT <u>  </u> FADE	This selects the connection method for the digital audio edit OUT point. 0: Cut processing 1: V Fade processing

The underline on the setting item denotes the initial setting.

# Setup menus

## USER menu

### <EDIT> (continued)

Item		Setting		Description
No.	Superimposed display	No.	Superimposed display	
313	AFTER CUE-UP	<u>0000</u> 0001 0002	<u>STOP</u> STILL1 STILL2	This selects the mode after cue-up operation is complete. 0: STOP mode 1: SHTL STILL mode 2: VAR STILL mode
315	AUD MEM UNIT	<u>0000</u> 0001 0002 0003	<u>OFF</u> MODE1 MODE2 MODE3	This selects the connection with the AJ-YA752 audio memory unit. 0: When the audio memory unit is not going to be used 1: When a voice-over operation is to be conducted 2: When audio cross channel editing is to be performed for CH2 3: When audio cross channel editing is to be performed for CH1 <b>&lt;Notes&gt;</b> • The RS-232C interface will function only when this menu item is set to 0 (OFF). • Refer to the Instruction Manual of the AJ-YA752 audio memory unit for details on how the modes are used.
316	VAR STEP	<u>0000</u> 0001	<u>FINE</u> COARSE	This selects the VAR speed during remote control operations. 0: The tape is played at the fine step speed. 1: The tape is played at a speed at which noise-less playback is possible in the $-0.43\times$ to $+1\times$ ( $-0.5\times$ to $+1\times$ ) range. <b>&lt;Notes&gt;</b> • The speeds in parentheses apply when a DV or DVCAM cassette is used. • At the 1(COARSE) setting, the phase cannot be synchronized from the editing controller.
317	VAR FWD MAX	<u>0000</u> 0001 0002	<u>+4.1</u> +1.85 +1	This sets the maximum VAR FWD speed. 0: $+4.1\times$ ( $+3.1\times$ ) speed 1: $+1.85\times$ ( $+1.85\times$ ) speed 2: $+1\times$ ( $+1\times$ ) speed <b>&lt;Notes&gt;</b> • The speeds in parentheses apply when a DV or DVCAM cassette is used. • At any speed setting other than 0 ( $+4.1\times$ ), the phase cannot be synchronized from the editing controller.
318	VAR REV MAX	<u>0000</u> 0001 0002 0003	<u>-4.1</u> -1.85 -1 -0.43	This sets the maximum VAR REV speed. 0: $-4.1\times$ ( $-3.1\times$ ) speed 1: $-1.85\times$ ( $-1.85\times$ ) speed 2: $-1\times$ ( $-1\times$ ) speed 3: $-0.43\times$ ( $-0.5\times$ ) speed <b>&lt;Note&gt;</b> The speeds in parentheses apply when a DV or DVCAM cassette is used.
319	JOG STEP	<u>0000</u> <u>0001</u>	<u>FINE</u> <u>COARSE</u>	This selects the JOG speed during remote control operations. 0: The tape is played at the fine step speed. 1: The tape is played at a speed at which noise-less playback is possible in the $-0.43\times$ to $+1\times$ ( $-0.5\times$ to $+1\times$ ) range. <b>&lt;Notes&gt;</b> • The speeds in parentheses apply when a DV or DVCAM cassette is used. • At the 1(COARSE) setting, the phase cannot be synchronized from an editing controller which synchronizes the phase using the JOG command.

The underline on the setting item denotes the initial setting.

## USER menu

### <EDIT> (continued)

Item		Setting		Description
No.	Superimposed display	No.	Superimposed display	
320	JOG FWD MAX	0000 0001 <u>0002</u>	+4.1 +1.85 <u>+1</u>	<p>This sets the maximum JOG FWD speed.</p> <p>0: +4.1× (+3.1×) speed 1: +1.85× (+1.85×) speed 2: +1× (+1×) speed</p> <p><b>&lt;Notes&gt;</b></p> <ul style="list-style-type: none"> <li>• The speeds in parentheses apply when a DV or DVCAM cassette is used.</li> <li>• At any speed setting other than 0 (+4.1×), the phase cannot be synchronized from an editing controller which synchronizes the phase using the JOG command.</li> </ul>
321	JOG REV MAX	0000 0001 0002 <u>0003</u>	-4.1 -1.85 -1 <u>-0.43</u>	<p>This sets the maximum JOG REV speed.</p> <p>0: -4.1× (-3.1×) speed 1: -1.85× (-1.85×) speed 2: -1× (-1×) speed 3: -0.43× (-0.5×) speed</p> <p><b>&lt;Note&gt;</b></p> <p>The speeds in parentheses apply when a DV or DVCAM cassette is used.</p>

The underline on the setting item denotes the initial setting.

# Setup menus

## USER menu

### <TAPE PROTECT>

Item		Setting		Description
No.	Superimposed display	No.	Superimposed display	
400	STILL TIMER	0000 0001 0002 0003 0004 0005 0006 0007 <u>0008</u>	0.5s 5s 10s 20s 30s 40s 50s 1min <u>2min</u>	This selects the length of time until tape protection mode is established when a DVCPRO tape is inserted and the unit is in STOP or STILL mode. (Unit: s = second, min = minute)
401	SRC PROTECT	<u>0000</u> 0001	<u>STEP</u> <u>HALF</u>	This selects the operation during the tape protection mode when the unit is left standing in the still status. 0: STEP FWD. 1: HALF LOADING. <b>&lt;Note&gt;</b> When STEP FWD is selected, operation will be automatically transferred to the standby OFF (half loading) mode as soon as the unit has been left standing in the STILL mode for a total of 30 minutes (or 1 minute for DV/DVCAM cassette).
402	DRUM STDBY	0000 <u>0001</u>	OFF <u>ON</u>	This selects the drum operation in the STANDBY OFF mode. 0: The drum stops rotating. 1: The drum continues rotating.
403	STOP PROTECT	0000 <u>0001</u>	<u>STEP</u> <u>HALF</u>	This selects the operation in the tape protection mode when the unit has been left standing in the STOP mode. 0: STEP FWD 1: HALF LOADING <b>&lt;Note&gt;</b> When STEP FWD is selected, operation will be automatically transferred to the standby OFF (half loading) mode as soon as the unit has been left standing in the STOP mode for a total of 30 minutes (or 1 minute for DV/DVCAM cassette).
404	DV STILL TMR	0000 0001 <u>0002</u> 0003	0.5s 5s <u>10s</u> 20s	This selects the length of time until tape protection mode is established when a DV/DVCAM tape is inserted and the unit is in STOP or STILL mode. (Unit: s = second) <b>&lt;Note&gt;</b> When using the unit in temperatures below 59°F (15°C), set this item to 10 seconds to protect the tape and video heads.

The underline on the setting item denotes the initial setting.

#### <Note>

In order to protect the tape and VTR helical heads, it is recommended that the Still Timer be set for automatic tape protection mode in 20 seconds or under.

## USER menu

### <TIME CODE>

Item		Setting		Description
No.	Superimposed display	No.	Superimposed display	
500	VITC POS-1	<u>0000</u> ⋮ <u>0006</u> ⋮ 0010	10L ⋮ <u>16L</u> ⋮ 20L	This sets the position where the VITC signal is to be inserted. (The same line as for VITC POS-2 in 501 cannot be selected.)
501	VITC POS-2	<u>0000</u> ⋮ <u>0008</u> ⋮ 0010	10L ⋮ <u>18L</u> ⋮ 20L	This sets the position where the VITC signal is to be inserted. (The same line as for VITC POS-1 in 500 cannot be selected.)
502	VITC BLANK	<u>0000</u> <u>0001</u>	BLANK <u>THRU</u>	This selects whether to output the VITC data to the positions selected by VITC POS-1 in 500 and VITC POS-2 in 501. 0: Data is not output. 1: Data is output.
503	TCG REGEN	<u>0000</u> 0001 0002	<u>TC&amp;UB</u> TC UB	This selects the signal to be regenerated when the time code generator (TCG) in the REGEN mode. 0: Both the time code and user bit are regenerated. 1: Only the time code is regenerated. 2: Only the user bit is regenerated.
504	REGEN MODE	<u>0000</u> 0001	<u>OFF</u> ON	This selects whether values used in the internal time code generator are preset from the front panel or remote controller or synchronized with time code values read from the tape. 0: Values are preset from the front panel or remote controller. (PRESET) 1: Values are synchronized with time code values read from the tape. (REGEN) <b>&lt;Note&gt;</b> When "1" is selected, values selected at set up menu No. 503 (TCG REGEN) are regenerated.
505	EXT TC SEL	<u>0000</u> 0001	<u>LTC</u> VITC	This selects the time code to be used when an external time code is to be used. 0: The LTC of the TIME CODE IN connector is used. 1: The video signal VITC is used.
506	BINARY GP	<u>0000</u> 0001 0002 0003 0004 0005 0006 0007	<u>000</u> 001 010 011 100 101 110 111	This sets the usage status of the user bit of the time code generated by the TCG. 0: NOT SPECIFIED (character set not specified) 1: ISO CHARACTER (8 bits character set based on ISO646, ISO2022) 2: UNASSIGNED 1 (undefined) 3: UNASSIGNED 2 (undefined) 4: UNASSIGNED 3 (undefined) 5: PAGE/LINE 6: UNASSIGNED 4 (undefined) 7: UNASSIGNED 5 (undefined)
507	PHASE CORR	<u>0000</u> 0001	<u>OFF</u> ON	This selects whether to control the phase correction of the LTC generated by the TCG. 0: Phase correction control is not performed. 1: Phase correction control is performed.
508	TCG CF FLAG	<u>0000</u> 0001	<u>OFF</u> ON	This selects whether the CF flag of the TCG is to ON. 0: CF flag is OFF. 1: CF flag is ON.

The underline on the setting item denotes the initial setting.

# Setup menus

## USER menu

### <TIME CODE> (continued)

Item		Setting		Description
No.	Superimposed display	No.	Superimposed display	
509	DF MODE	<u>0000</u> 0001	<u>DF</u> NDF	This selects the DF/NDF mode for CTL and TCG. 0: Drop frame mode. 1: Non-drop frame mode. <b>&lt;Note&gt;</b> No. 509 is valid when the CONTROL is LOCAL or LOCAL ENA of item 004 to "ENA".
510	RUN MODE	<u>0000</u> 0001	<u>REC</u> FREE	This selects the time code generator run mode. 0: Generator runs only during recording. 1: Generator runs during usual operation. <b>&lt;Note&gt;</b> Even if "0" is selected, the time code generator runs during usual operation when "1" is selected at the setting menu No. 504 (REGEN MODE).
511	TC OUT REF	<u>0000</u> 0001	<u>V OUT</u> TC_IN	This is used to switch the phase of the time code, which is output from the TIME CODE OUT connector, for the external LTC input when the TC INT/EXT switch is at the EXT position. (In EE mode only) 0: Time code is synchronized with output video signal. 1: Time code is synchronized with external time code input.
512	VITC OUT	<u>0000</u> 0001	<u>SBC</u> VAUX	For selecting the method used to output the VITC which is to be superimposed onto the output video signal. 0: During recording: The input time code, which was selected using the setup menu item No. 505 (EXT TC SEL) setting and TC IN/EXT switch, is output as the VITC. During playback: The time code recorded in the SBC area is output as the VITC. 1: During recording: The time code detected from the input video signals is output as the VITC. During playback: The time code recorded in the VAUX area is output as the VITC. <b>&lt;Note&gt;</b> When video signals are recorded, the time code detected from the input video signals is automatically recorded in the VAUX area.

The underline on the setting item denotes the initial setting.

### SBC (Sub Code Data) area

This area exists independently from the video and audio data areas on the helical track, and it contains the time code which complies with the SMPTE/EBU standard. As with the conventional LTC (Longitudinal Time Code), the time code can be read even during rewinding and fast forwarding or when the tape has stopped.

### VAUX (Video Auxiliary Data) area

This area exists inside the video data area on the helical track, and it contains additional information on the video data.

### <Note>

Control over the time code or user bit during tape playback is exercised using the data recorded in the SBC area. In other words, it is exercised over all the data which has been recorded in the SBC area including the data shown on the counter display in the center of the front panel and on the superimposed displays as well as the communication data for a component such as the editing controller.



## USER menu

### <VIDEO>

Item		Setting		Description
No.	Superimposed display	No.	Superimposed display	
600	P <sub>B</sub> /P <sub>R</sub> IN LV	0000 <u>0001</u>	MII <u>B-CAM</u>	This selects the component input signal level. 0: MII level. 1: β cam level.
601	INT SG	<u>0000</u> 0001 0002	<u>OFF</u> BB CB	For selecting whether an internal signal is to be generated. 0: No signal is generated. 1: A black burst signal is generated. 2: A 100% color bar signal is generated. <b>&lt;Notes&gt;</b> • The INT SG message appears for 2 seconds when recording commences. • If the VIDEO INPUT switch  is set to DVCPRO/DV, the audio signals will also serve automatically as the internal signals when a video signal has been selected as the internal signal by this menu item setting.
602	INPUT C KILL	0000 <u>0001</u>	B/W <u>AUTO</u>	This selects color killer processing for the video input signals. 0: The signals are forcibly processed as B/W signals. 1: The signals are automatically processed.
603	OUT VSYNC	<u>0000</u> 0001	<u>N-VF</u> VF	This selects whether to float the vertical sync position of the video output in order to align the video output phase with the input in the EE/record/edit modes. 0: Signals are not floated. 1: Signals are floated.
604	V-MUTE SEL	0000 <u>0001</u>	N-MUTE <u>LOW_RF</u>	This selects whether the video output signal is to be muted when the blank portion of the tape is detected during playback. 0: No muting 1: Muting (picture turns grey).
605	CC (F1) BLANK	0000 <u>0001</u>	BLANK <u>THRU</u>	This selects ON or OFF for the closed caption signal in the first field. 0: Forced blanking performed. 1: Blanking not performed.
606	CC (F2) BLANK	0000 <u>0001</u>	BLANK <u>THRU</u>	This selects ON or OFF for the closed caption signal in the second field. 0: Forced blanking performed. 1: Blanking not performed.
608	FREEZE SEL	<u>0000</u> 0001	<u>FIELD</u> FRAME	For selecting how the still picture is to be output. 0: Field output 1: Frame output <b>&lt;Note&gt;</b> When frame output is selected, the frame slow mode will be established during slow motion as well.
611	EDH	0000 <u>0001</u>	<u>OFF</u> ON	This selects whether to superimpose EDH onto the serial output signals. 0: EDH is not superimposed. 1: EDH is superimposed. <b>&lt;Notes&gt;</b> • This display will not appear unless the AJ-YA455P serial interface board (optional accessory) has been installed. • Even when 1 (ON) has been selected, EDH is not superimposed at the SERIAL OUT 3 connector if the SUPER ON/OFF switch is at the ON position.

The underline on the setting item denotes the initial setting.

# Setup menus

## USER menu

### <VIDEO> (continued)

Item		Setting		Description
No.	Superimposed display	No.	Superimposed display	
612	WIDE SELECT	<u>0000</u> 0001 0002	<u>AUTO</u> WIDE NORMAL	<p>This selects the operation to be conducted in response to the WIDE information.</p> <p>0: During recording, if the S1-VIDEO input signals contain WIDE information, the WIDE information is recorded on the tape. During playback, if WIDE information is on the tape, it is added to the S1-VIDEO output signals.</p> <p>1: During recording, the WIDE information is recorded on the tape regardless of whether the S1-VIDEO input signals contain the WIDE information. During playback, the WIDE information is added to the S1-VIDEO output signals regardless of whether the WIDE information is on the tape. → Forced WIDE ON</p> <p>2: During recording, the WIDE information is not recorded on the tape regardless of whether the S1-VIDEO input signals contain the WIDE information. During playback, the WIDE information is not added to the S1-VIDEO output signals regardless of whether the WIDE information is on the tape. → Forced WIDE OFF</p> <p><b>&lt;Note&gt;</b> This item is effective during recording at the start of the recording and during playback at all times. Therefore, when its setting has been changed during recording, the MENU contents will be changed but no change will occur in the actual operation.</p>
613	VIN SETUP	<u>0000</u> <u>0001</u>	<u>THRU</u> <u>CUT</u>	<p>This selects whether the composite signal is to be recorded with setup or without setup.</p> <p>0: When recording signals with no setup. 1: When recording signals with 7.5% setup.</p> <p><b>&lt;Note&gt;</b> When recording composite signals, be sure to double-check whether the signals are to be recorded with or without setup.</p>
620	Pb/Pr OUT LV	<u>0000</u> <u>0001</u>	MII <u>B-CAM</u>	<p>For selecting the analog component output level.</p> <p>0: MII level 1: Betacam level</p>

The underline on the setting item denotes the initial setting.

## USER menu

### <AUDIO>

Item		Setting		Description
No.	Superimposed display	No.	Superimposed display	
700	CH1 IN LV	<u>0000</u> 0001 0002 0003	4dB <u>0dB</u> -20dB -60dB	This selects the audio input (CH1) reference level switching.
701	CH2 IN LV	<u>0000</u> 0001 0002 0003	4dB <u>0dB</u> -20dB -60dB	This selects the audio input (CH2) reference level switching.
703	CH1 OUT LV	<u>0000</u> 0001 0002	4dB <u>0dB</u> -20dB	This selects the audio output (CH1) reference level switching.
704	CH2 OUT LV	<u>0000</u> 0001 0002	4dB <u>0dB</u> -20dB	This selects the audio output (CH2) reference level switching.
714	REC CH1	<u>0000</u> 0001 0002	<u>CH1</u> CH2 CH1+2	This selects the input signal to be recorded on the audio CH1 track. 0: Audio input CH1 signal. 1: Audio input CH2 signal. 2: Mixed audio input CH1 and CH2 signal.
715	REC CH2	<u>0000</u> 0001 0002	CH1 <u>CH2</u> CH1+2	This selects the input signal to be recorded on the audio CH2 track. 0: Audio input CH1 signal. 1: Audio input CH2 signal. 2: Mixed audio input CH1 and CH2 signal.
716	REC CUE	<u>0000</u> 0001 0002	<u>CH1</u> CH2 CH1+2	This selects the input signal recorded in CUE. 0: The signal selected by SETUP-MENU No. 714 is recorded. 1: The signal selected by SETUP-MENU No. 715 is recorded. 2: The signal selected by SETUP-MENU No. 714 and No. 715 are mixed and recorded.
718	DV OUTPUT	<u>0000</u> 0001 0002	<u>ST1</u> ST2 ST1+2	This selects the AUDIO CH1 and CH2 output signals during DV or DVCAM format playback. 0: The CH1 track signals are output to CH1 and the CH2 track signals to CH2. (Only the sound during shooting is output.) 1: The CH3 track signals are output to CH1 and the CH4 track signals to CH2. (Only the audio dubbing sound is output.) 2: The mixed CH1 and CH3 track signals are output to CH1 and the mixed CH2 and CH4 track signals to CH2. (The sound during shooting and audio dubbing sound are output simultaneously.) <b>&lt;Note&gt;</b> This menu item takes effect only when a DV or DVCAM cassette tape with a 32 kHz/4-channel recording is played back.
719	PB FADE	<u>0000</u> 0001 0002	<u>AUTO</u> CUT FADE	This selects the processing method for the audio edit points (IN point, OUT point) during playback. 0: According to the status during recording. (Setup menus No. 309, 310) 1: Forced CUT 2: Forced FADE

The underline on the setting item denotes the initial setting.

# Setup menus

## USER menu

### <AUDIO> (continued)

Item		Setting		Description
No.	Superimposed display	No.	Superimposed display	
720	EMBEDDED AUD	<u>0000</u> 0001	OFF <u>ON</u>	This selects whether to superimpose the audio data onto the serial output. 0: Data is not superimposed. 1: Data is superimposed. <b>&lt;Note&gt;</b> This display will not appear unless the AJ-YA455P serial interface board (optional accessory) has been installed.
721	LINE CH SEL	<u>0000</u> 0001	PCM AUTO	This selects the audio output for CH1 and CH2. 0: PCM AUDIO is output. 1: PCM AUDIO is output in the -0.43x to 1x speed range; in all other cases, CUE is automatically output. <b>&lt;Note&gt;</b> The PCM AUDIO output CH1 and CH2 signals are output separately regardless of the position selected for the AUDIO MONITOR SELECT switch.
722	INT SG	<u>0000</u> 0001	<u>OFF</u> ON	This selects whether the internal signal is to be used for the audio input signal. 0: The internal signal is not selected. 1: The internal signal is selected. <b>&lt;Notes&gt;</b> • The internal signal has a frequency of 997 Hz. • This setting is invalid if the VIDEO INPUT switch  has been set to DVCPRO/DV.
723	DV PB ATT	<u>0000</u> 0001	<u>OFF</u> ON	This selects the audio output level for DV format playback. 0: The audio output level is not attenuated. 1: The audio output level is attenuated (reduced).
729	REC PT MUTE	<u>0000</u> 0001	<u>OFF</u> ON	For selecting whether to mute the sound at the joins between recordings during DV or DVCAM cassette playback. 0: The sound is not muted. 1: The sound is muted.
731	REF LEVEL	<u>0000</u> 0001 0002	<u>FS-20</u> FS-18 FS-12	For setting the audio reference level. 0: Full scale, -20 dB 1: Full scale, -18 dB 2: Full scale, -12 dB

The underline on the setting item denotes the initial setting.

## USER menu

### <MENU>

Item		Setting		Description
No.	Superimposed display	No.	Superimposed display	
A00	LOAD	<u>0000</u> 0001 0002 0003	<u>USER2</u> USER3 USER4 USER5	This selects the user file whose contents will be loaded into USER1. 0: The USER2 file contents are loaded. 1: The USER3 file contents are loaded. 2: The USER4 file contents are loaded. 3: The USER5 file contents are loaded. <b>&lt;Note&gt;</b> When the SET button is pressed after loading, the setting will be stored in the memory. When the MENU button is pressed, the setting will not be changed.
A01	SAVE	<u>0000</u> 0001 0002 0003 0004	<u>USER2</u> USER3 USER4 USER5 LOCKED	This selects the user file into which the USER1 settings will be saved. 0: The settings are saved in USER2. 1: The settings are saved in USER3. 2: The settings are saved in USER4. 3: The settings are saved in USER5. 4: This display appears when all the user files are in the change prohibit status. <b>&lt;Notes&gt;</b> • User files whose status have been set to change prohibit cannot be selected. • When all the user files are in the change prohibit status, the "LOCKED" display appears and the contents cannot be saved.
A02	P.ON LOAD	<u>0000</u> 0001 0002 0003 0004	<u>OFF</u> USER2 USER3 USER4 USER5	This loads the contents of the selected user file into USER1 and it starts operation with the USER1 settings when the power is turned on. 0: Operation is started with the settings of the previously set user file. 1: The contents of USER2 are loaded into USER1 and operation is started with the USER1 settings. 2: The contents of USER3 are loaded into USER1 and operation is started with the USER1 settings. 3: The contents of USER4 are loaded into USER1 and operation is started with the USER1 settings. 4: The contents of USER5 are loaded into USER1 and operation is started with the USER1 settings.
A03	MENU LOCK	<u>0000</u> 0001	<u>OFF</u> ON	This selects whether to set or release the user file (USER2 – USER5) lock mode. 0: The lock is released (changes can be made). 1: The lock is set (changes are prohibited). <b>&lt;Note&gt;</b> The lock cannot be set for USER1.

The underline on the setting item denotes the initial setting.

### <Notes>

- No. A00 (LOAD), No. A01 (SAVE) and No. A02 (P.ON LOAD) are the menu items which can be set only for USER1. They are not displayed with the USER2 – USER5 files.
- No. A03 (MENU LOCK) is the menu item which can be set only for the USER2 – USER5 files. It is not displayed with USER1.

# Time code/user bit

---

## Time code

The time code is used when the time code signal generated by the time code generator (time code signal generator) is to be recorded on the tape, its values are to be read by the time code reader (time code signal reader), and the absolute position of the tape is to be displayed in increments of hours, minutes, seconds and frames.

The time code is written in the sub-code area (data area) of the helical track. This enables insert editing to be conducted independently using the time code alone. In addition, the VTR's playback speed can be read from the stop mode to slow-motion playback up to high-speed play (approx. 100× normal speed).

The time code values are indicated using the display and superimpose functions.

TCR 00 : 07 : 04 : 24  
          ↑      ↑      ↑      ↑  
          Hours | Minutes Seconds Frames

### <Note>

Values appear as shown below on the superimposed display or front display.

Playback: Time code reader values

REC, EE: Time code generator values

Time code generator values can be checked when the REC button is pressed even during playback.

## User bit

“User bit” refers to the 32-bit (8-digit) data frame among the time code signals which has been released to users. It enables operator numbers values to be recorded.

The alphanumeric characters which can be used for the user bit are the figures 0 to 9 and the letters A to F.

# Recording internal/external time codes

---

## 1. Setting the internal time code

- 1** Place the VTR in the stop mode.
- 2** Press the CTL/TC/UB/REMAIN button until TC is selected.
- 3** Set the TC INT/EXT switch to INT. (Internal time code selected)
- 4** Set the RUN MODE. (setup menu No. 510)  
**REC (RUN):** The time code runs at the same time as the recording proceeds.  
**FREE (RUN):** The time code runs in the same way as the time regardless of the VTR's operation.
- 5** Set the REGEN MODE. (setup menu No. 504)  
**ON (REGEN):** Continuity is maintained with the recorded time code before editing. (Detailed settings are also possible using the menu settings. See the menu items below.)  
Setting menu No. 503 (TCG REGEN)  
**OFF (PRESET):** Recording starts from the value set with the TC PRESET button.
- 6** TC PRESET value setting [with REGEN MODE OFF (PRESET)]  
Use the TC PRESET button to set the start number of the time code or user bit.
  - 1** The leftmost digit flashes.  
Align the flashing light and the digit to be set with the cursor buttons (◀, ▶).
  - 2** Press the cursor button ▲ or ▼ to change the value.  
Each time the button is pressed, the number changes. The setting range is given below.
    - **When using the time code and user bit in real time**  
00:00:00:00 – 23:59:59:29
    - **User bit**  
00 00 00 00 – FF FF FF FF
  - 3** Repeat steps 1 and 2 to change the value.
  - 4** When the setting of the start number is completed, press the SET button. In the FREE RUN mode, the time code now starts running.
  - 5** Proceed with the recording or editing.

## 2. Setting the external time code (TC switch → EXT)

- 1** Place the VTR in the stop mode.
- 2** Press the CTL/TC/UB/REMAIN button until TC is selected.
- 3** Set the TC INT/EXT switch to EXT. (External time code selected)
- 4** Setup menu No. 505 (EXT TC SEL) can be set as follows.  
**LTC:** The LTC signal input to the TIME CODE IN connector (BNC) on the rear jack panel is recorded as the time code.  
**<Note>** The LTC signal must be synchronized with the video signal.  
**VITC:** The input video signal's VITC is recorded as the time code.

# Reproducing the time code/user bit

---

- 1** Place the unit in the stop mode.
- 2** Press the CTL/TC/UB/REMAIN button until TC or UB is selected.  
**TC:** The time code is displayed.  
**UB:** The user bit is displayed.
  - When it is no longer possible to read the time code, it is interpolated using the CTL signal.
- 3** Press the PLAY button.  
Playback now commences, and the time code appears on the display.  
If the SUPER ON/OFF switch is at ON, the time code value is superimposed onto the video signals which are output from the VIDEO OUT 3 or SERIAL OUT 3\* connector.  
\* The superimposing takes effect only when the AJ-YA455P serial interface board (optional accessory) is used.

## <Notes>

- The colon between the seconds and frames changes to a period when the drop frame time code is read.
- When the time code signal cannot be read, the time code is automatically interpolated by the CTL signal.

The front panel counter display appears as shown below.

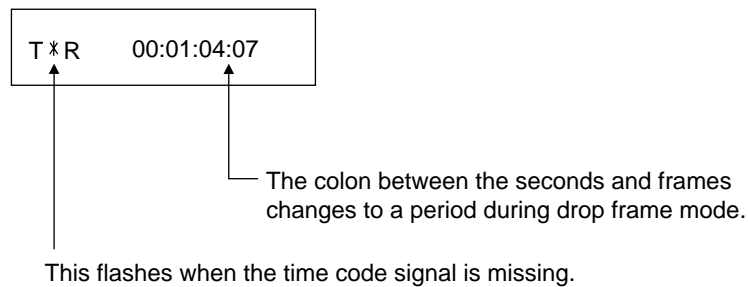



# Superimpose screen

The superimposed displays appear as shown below. The control signal, time code, etc. are indicated by abbreviations.

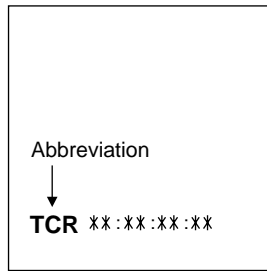

TV monitor

CTL (control signal)  
TCR (time code playback value)  
TCG (time code generator value)  
UBR (TC user bit playback value)  
UBG (user bit generator value)

## Characters displayed

The background of characters superimposed on the display can be changed using setup menu No. 007 (CHARA TYPE).

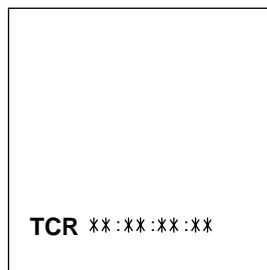

TV monitor

## Display position

The position of the characters superimposed on the display can be changed using setup menus No. 001 (CHARA H-POS) and No. 002 (CHARA V-POS).

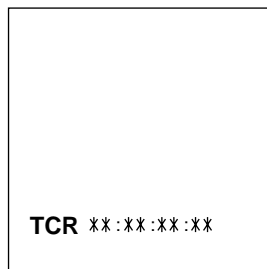

TV monitor

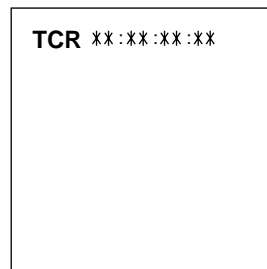

TV monitor

## Operation mode

The VTR's operation mode can also be displayed using setup menu No. 003 (DISPLAY SEL).

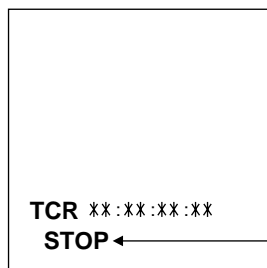

TV monitor

# Servo reference

As the servo reference signal, this unit automatically selects the input video signal selected by the VIDEO INPUT switch, the reference video signal which is supplied from the REF VIDEO input connector or the internal sync signal.

When the signal is selected, the unit's mode and servo reference stand in the relationship shown in the flowchart presented below.

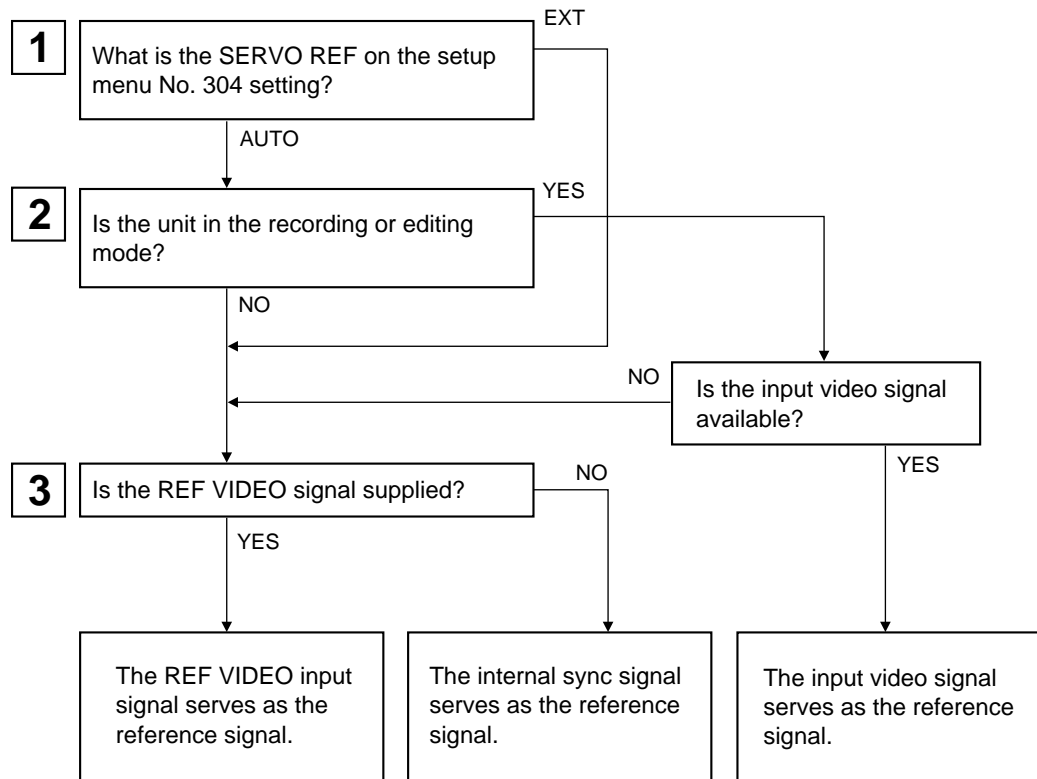

# Rack mounting

The unit can be mounted into a 19-inch standard rack if the optional rack-mounting adaptors (AJ-MA75P) are used. For the installation rails, it is recommended that the rail and bracket for 18" length (model number CC3061-99-0400) of Chassis Trak be used. (The complete slide rail and bracket unit is not available from Panasonic.) For further details, consult with your dealer.

- 1 Refer to below for the places where they are to be secured with the screws.

### Locations where the screws are secured on right (R) side of inner members of slide rails

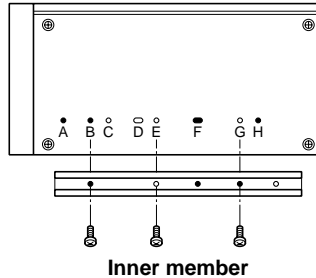

Attach the inner members at the same symmetrical positions on the left (L) side.

Note: The letters "A" to "H" are not actually marked on the side panels.

The length of the screws used is subject to restriction. Use screws which are less than 2/5" long in their place.

6 screws must be used to secure each inner member.

- 2 Attach the outer member brackets to the rack.  
Check that the height is the same for the left and right brackets.
- 3 Remove the four screws at the front for attaching the left and right side panels.
- 4 Attach the AJ-MA75P rack mount adaptor using the 4 screws included.

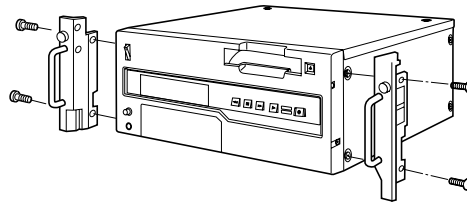

- 5 Remove the 4 rubber legs from the bottom of the unit, and install the unit in the rack.  
After the unit has been installed, check that it moves smoothly along the rails.

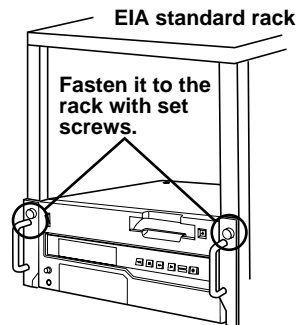

### <Notes>

- Keep the temperature inside the rack to between +41°F (5°C) and +104°F (40°C).
- Bolt the rack securely to the floor so that it will not topple over when the VTR is drawn out.

## Video head cleaning

This unit is equipped with an auto head cleaning function which automatically reduces the amount of dirt on the video heads. However, in order to maximize the unit's reliability, it is recommended that the video heads be cleaned as and when appropriate.

For further details on how to actually clean the heads, consult with one of our service companies or with your dealer.

## Condensation

Condensation occurs due to the same principle involved when droplets of water form on a window pane of a heated room. It occurs when the unit or tape is moved between places where the temperature or humidity varies greatly or when, for instance:

- It is moved to a very humid place full of steam or a room immediately after it has been heated up.
- It is suddenly moved from a cold location to a hot or humid location.

When moving the unit to locations such as these, leave it standing for about 10 minutes rather than switching on the power immediately.

If condensation has formed on or in the unit, the "E-20" code flashes in the counter display and the cassette tape is automatically ejected.

Keep the power supplied and simply wait until the "E-20" code goes off.

### <Note>

Do not use alcohol, benzene, paint thinners or any other solvents. They cause discoloration of the unit's external parts surfaces and mar the paint finish.

## Installing the mechanism dust protector

### CAUTION:

These servicing instructions are for use by qualified service personnel only. To reduce the risk of electric shock do not perform any servicing other than that contained in the operating instructions unless you are qualified to do so.

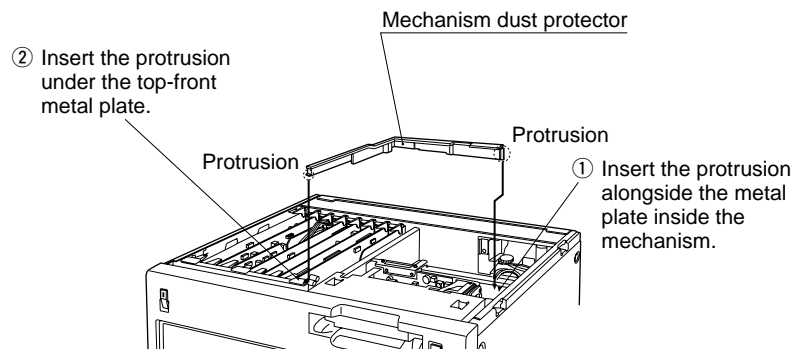

- Do not insert fingers or any objects into the video cassette holder.
- Avoid operating or leaving the unit near strong magnetic fields. Be especially careful of large audio speakers.
- Avoid operating or storing the unit in an excessively hot, cold, or damp environment as this may result in damage both to the recorder and to the tape.
- Do not spray any cleaner or wax directly on the unit.
- If the unit is not going to be used for a length of time, protect it from dirt and dust.
- Do not leave a cassette in the recorder when not in use.
- Do not block the ventilation slots of the unit.

- Use this unit horizontally and do not place anything on the top panel.
- Cassette tape can be used only for one-side, one direction recording. Two-way or two-track recordings cannot be made.
- Cassette tape can be used for either Color or Black & White recording.
- Do not attempt to disassemble the recorder. There are no user serviceable parts inside.
- If any liquid spills inside the recorder, have the recorder examined for possible damage.
- Refer any needed servicing to authorized service personnel.

# Error messages

When a warning occurs in this unit, an error number appears at the counter display. Opening the DIAG menu will display the error description on the monitor. Also, when an abnormal operation is detected in this unit, an error number flashes on the counter display.

## DIAG menu

This display the VTR information. VTR information includes “WARNING” information and “HOURS METER” (usage time) information. A DIAG menu appears on the monitor when the monitor is connected to the VIDEO OUT 3 connector on the connector section.

## Displaying the DIAG menu

- 1** Press the DIAG button.  
The DIAG menu screen is displayed on the monitor, and the error number is displayed on the counter display.
- 2** The “WARNING” information and “HOURS METER” information can be switched by pressing the cursor buttons (◀, ▶).
- 3** Press the DIAG button again to return to the original display.

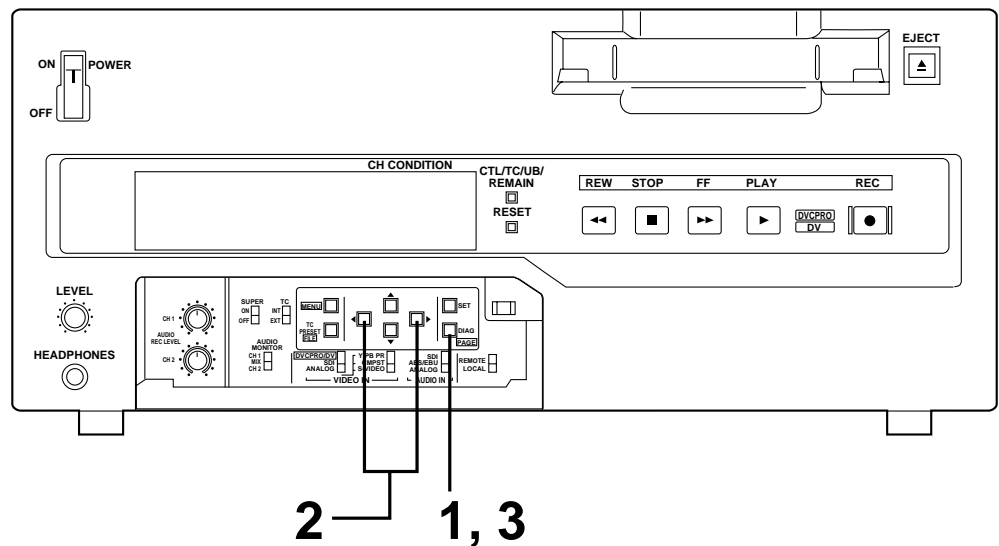

### “WARNING” information display

- A warning message is displayed on the monitor whenever a warning occurs. When warnings have not been detected, “NO WARNING” is displayed on the monitor, and “Err-” is displayed on the counter display.
- When multiple warning occur, the descriptions for each warning can be checked by using the cursor buttons (▲, ▼).

# Error messages

## Displaying the “HOURS METER” information

Press the cursor buttons (▲, ▼) to move the cursor (\*).

The number for the item where the cursor is located is shown on the counter display.

Item No.	Item	Description
H00	OPERATION	Displays the time that the power has been supplied in one-hour units.
H01	DRUM RUN	Displays the time that the drum has been rotating in one-hour units.
H02	TAPE RUN	Displays the time that the tape has been running during FF, REW, PLAY, SEARCH (JOG, VAR, SHTL), REC, and EDIT modes (except for STILL in the JOG, VAR or SHTL mode) in one-hour units.
H03	THREADING	Displays the number of times for threading/unthreading in single units.
H11	DRUM RUN r	Displays the time that the drum has been rotating in one-hour units. (Can be reset)
H12	TAPE RUN r	Displays the time that the tape has been running during FF, REW, PLAY, SEARCH (JOG, VAR, SHTL), REC, and EDIT modes (except for STILL in the JOG, VAR or SHTL mode) in one-hour units. (Can be reset)
H13	THREADING r	Displays the number of times for threading/unthreading in single units. (Can be reset)
H30	POWER ON	This displays the number of power-on times with one power-on counting as one time.

### <Note>

The resettable items in the “HOURS METER” information are reset by the service personnel when performing maintenance or other work.

If T&S&M is selected in the setup menu No. 003 (DISPLAY SEL), a message appears in the mode display whenever a warning or error occurs. When multiple events occur, the event with the highest priority is displayed.

Priority	Counter display and monitor display	Description
High ↑ ↓ Low	Error messages (See error message table)	When an abnormal operation is detected in this machine, an error number flashes on the counter display and an error message is displayed.
	INT SG	If “BB” or “CB” in No. 601 (INT SG) in the setup menu is selected, pressing the REC button (E to E mode) will display “INT SG” for the first two seconds. This is also displayed for the first two seconds when starting editing from the external controller.
	NO INPUT	If there is no input signal (except for analog audio) to the connector selected using the VIDEO INPUT switch, pressing the REC button (E to E mode) will display “NO INPUT” for the first two seconds. This is also displayed for the first two seconds when starting editing from the external controller.
	Warning messages (See warning message table)	When a warning occurs in this unit, an error number appears at the counter display and warning message is displayed. When multiple warnings occur, the warning with the highest priority is displayed.

## Warning

Priority	Error No.	TV monitor display*	Description	VTR operation
High ↑ ↓ Low	<b>E-10*</b> <b>(Err-10)</b>	FAN STOP	Error No. lights when a fan motor stops operating.	Continued
	<b>E-09*</b> <b>(Err-09)</b>	NO RF	This appears when a blank exceeding 1 second is detected on the tape during playback.	Continued
	<b>E-00*</b> <b>(Err-00)</b>	SERVO NOT LOCKED	Error No. lights when servo disturbances continue for 3 or more seconds during playback, recording or editing.	Continued
	<b>E-01*</b> <b>(Err-01)</b>	LOW RF	Error No. lights when envelope levels approx. 1/3 that of normal levels are detected for more than 1 sec. during playback, recording or editing.	Continued
	<b>E-02*</b> <b>(Err-02)</b>	HIGH ERROR RATE	Error No. lights when the error rate increases and correction/interpolation is performed on either the video or audio playback signal.	Continued

\* Displays when warning information is checked by pressing the DIAG button.

## AUTO OFF mode

The following error number flashes on the counter display section.

Error No.	TV monitor display	Descriptions	VTR operation (VTR measures)
<b>E-20</b>	DEW	When condensation is detected, the error no. display flashes, and the unit goes into EJECT mode. The drum rotates after the cassette tape is ejected to remove condensation. When the condensation has been removed, the error no. display disappears and the VTR may be used. <b>&lt;Notes&gt;</b> 1) The drum rotates as soon as condensation is detected when the unit is in EJECT mode. 2) When condensation is detected while a cassette tape is inserted, drum rotation stops, the cassette tape is ejected and the drum rotation begins again.	EJECT
<b>Any other number</b>		If any other number appears frequently, ask your dealer to inspect the unit.	

# Connector signals

## VIDEO IN

SERIAL IN (DIGITAL)	BNC × 2	Active through (Option)
Y, P <sub>B</sub> , P <sub>R</sub> (ANALOG)	BNC × 3	
VIDEO IN	BNC × 2	Loop-through, 75Ω termination switch provided
REF VIDEO IN	BNC × 2	Loop-through, 75Ω termination switch provided
S1-VIDEO IN	4-pin × 1	

## VIDEO OUT

SERIAL OUT(DIGITAL)	BNC × 3	(Option)
Y, P <sub>B</sub> , P <sub>R</sub> (ANALOG)	BNC × 3	
VIDEO OUT	BNC × 3	
S1-VIDEO OUT	4-pin × 1	

## AUDIO IN

SERIAL IN (DIGITAL)	BNC × 2	Active through (Option)
AUDIO IN (DIGITAL)	BNC × 1	CH1/CH2 AES/EBU format
AUDIO IN (ANALOG)	XLR × 2	CH1, CH2
TIME CODE IN	BNC × 1	

Pin No.	Signal
1	GND
2	HOT
3	COLD

## AUDIO OUT

SERIAL OUT (DIGITAL)	BNC × 3	(Option)
AUDIO OUT (DIGITAL)	BNC × 1	CH1/CH2 AES/EBU format
AUDIO OUT (ANALOG)	XLR × 2	CH1, CH2
TIME CODE OUT	BNC × 1	
MONITOR OUT	PHONO × 1	
HEADPHONES (front)	1/4" phone × 1	

## IEEE1394

IN/OUT	6-pin × 1	(Option)
--------	-----------	----------

## RS-422A REMOTE (9P)

### REMOTE

Pin No.	Signal	Pin No.	Signal	Pin No.	Signal
1	FRAME GROUND	4	RECEIVE COMMON	7	TRANSMIT B
2	TRANSMIT A	5	—————	8	RECEIVE A
3	RECEIVE B	6	TRANSMIT COMMON	9	FRAME GROUND



---

---

## RS-232C REMOTE (25-pin D-SUB straight cable supported)

Pin No.	Abbreviation	Circuit	Description
1	FRAME GROUND	Protective ground	Frame ground
2	TxD	Transmitted data	Receives data from the PC.
3	RxD	Received data	Sends data to the PC.
4	RTS	Request to send	Shorted with pin 5.
5	CTS	Clear to send	Shorted with pin 4.
6	DSR	Data set ready	Positive power output after communication enable status
7	SG	Signal ground	Signal ground
20	DTR	Data terminal ready	No processing

## ENCODER REMOTE (15P)

Pin No.	Signal	Pin No.	Signal	Pin No.	Signal
1	—————	6	SYSTEM H	11	RET GND
2	SET UP	7	SYS.SC COARSE (2)	12	—————
3	C LEVEL	8	-9V	13	—————
4	GND	9	HUE	14	SYS.SC FINE
5	+9V	10	VIDEO LEVEL	15	SYS.SC COARSE (1)

# Printed circuit board

**CAUTION:**

These servicing instructions are for use by qualified service personnel only. To reduce the risk of electric shock do not perform any servicing other than that contained in the operating instructions unless you are qualified to do so.

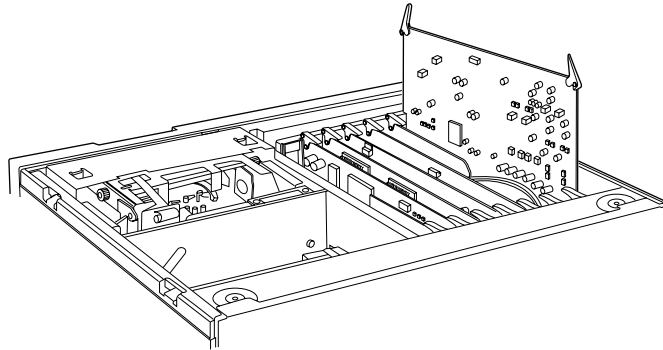

Printed circuit board	Abbr. name	Full name	Function	Factory setting
F1 board AUDIO	SW100	Audio Input Impedance SW	This sets the CH1 audio input impedance. HIGH/600Ω	HIGH
	SW101	Audio Input Impedance SW	This sets the CH2 audio input impedance. HIGH/600Ω	HIGH

# Specifications

## GENERAL

<b>Power supply:</b> AC 120 V, 50 – 60 Hz
<b>Power consumption:</b> 95 W

**Operating ambient temperature:** 41°F to 104°F (5°C to 40°C)  
**Operating ambient humidity:** 10% to 90% (no condensation)  
**Weight:** 31.46 lbs (14.3 kg)  
**Dimensions (W × H × D):** 16-3/4 × 6-15/16 × 16-3/8 inches  
(424 × 175.2 × 415 mm)

**Recording format:** DVCPRO format/DV format  
**Recording video signals:** 525i  
**Recording audio signals:** 48 kHz, 16 bits, 2 channels (DVCPRO)  
**Recording tracks:** Digital video/audio helical track  
Time code; Recorded in sub-code area  
Digital audio; 2 channels  
Cue Track; 1 track  
Control (CTL); 1 track

**Tape speed:** 33.820 mm/sec  
**Recording time:** 126 minutes (with AJ-P126LP)  
66 minutes (with AJ-P66MP)

**Tape:** 1/4-inch thin magnetic layer metal tape  
**FF/REW time:** Less than 3 min (with AJ-P126LP)  
Less than 2 min (with AJ-P66MP)

**Editing accuracy:** ±0 frame (using time code)  
**Tape timer accuracy:** ±1 frame (using continuous CTL signal)  
**Servo lock time:** Less than 0.5 sec. (color framing/  
standby ON)

## VIDEO

(Digital video)  
**Sampling frequencies:** Y; 13.5 MHz/P<sub>B</sub>, P<sub>R</sub>; 3.375 MHz  
**Quantizing:** 8 bits  
**Video compression system:** DV-based compression (SMPTE314M)  
**Video compression ratio:** 1/5 (DVCPRO)  
**Error correction:** Reed-Solomon product code  
**Video recording/playback bit rate:** 25 Mbps (DVCPRO)  
**Samples × number of effective lines:** 720 × 480/frame (DVCPRO)

### (Digital IN/Analog component OUT)

**Video bandwidth:** Y; 30 Hz to 5.5 MHz (±1.0 dB)  
P<sub>B</sub>, P<sub>R</sub>; 30 Hz to 1.3 MHz (±1.0 dB)  
**S/N ratio:** Better than 56 dB  
**K factor:** Less than 2%

### (Analog component IN/Analog component OUT)

**Video bandwidth:** Y; 30 Hz to 5.5 MHz (–1.5 dB to +1.0 dB)  
P<sub>B</sub>, P<sub>R</sub>; 30 Hz to 1.3 MHz  
(–2.0 dB to +1.0 dB)  
**S/N ratio:** Better than 55 dB  
**K factor:** Less than 2%

### (Analog composite IN/Analog composite OUT)

**Video bandwidth:** Y; 30 Hz to 4.5 MHz (–1.5 dB to +1.0 dB)  
**DG:** Less than 4%  
**DP:** Less than 3°  
**Y/C delay:** Better than 20 ns  
**K factor:** Less than 3%  
**S/N ratio:** Better than 48 dB

### (Video input connector)

**Analog component input:** BNC×3 (Y, P<sub>B</sub>, P<sub>R</sub>)  
Y; 1.0 V<sub>p-p</sub>, 75Ω  
P<sub>B</sub>, P<sub>R</sub>; 0.486/0.7 V<sub>p-p</sub> switchable, 75Ω  
(75% color bar, 7.5% setup)

**Analog composite input:** BNC×2, loop-through, 75Ω on/off  
**S1 VIDEO input:** S terminal (4-pin)×1  
Y; 1.0 V<sub>p-p</sub>, 75Ω  
C; 0.286 V<sub>p-p</sub> (burst), 75Ω

**Reference input:** Analog composite  
BNC×2, loop-through, 75Ω on/off

**Serial digital component input (option):** Complies with SMPTE259M-C standard,  
BNC×2, active through

### (Video output connector)

**Analog component output:** BNC×3 (Y, P<sub>B</sub>, P<sub>R</sub>)  
Y; 1.0 V<sub>p-p</sub>, 75Ω  
P<sub>B</sub>, P<sub>R</sub>; 0.486/0.7 V<sub>p-p</sub> switchable, 75Ω  
(75% color bar, 7.5% setup)

**Analog composite output:** BNC×3  
Video1/video2/video3 (superimpose on/off)

**S1 VIDEO output:** S terminal (4-pin)×1  
Y; 1.0 V<sub>p-p</sub>, 75Ω  
C; 0.286 V<sub>p-p</sub> (burst), 75Ω

**Serial digital component output (option):** Complies with SMPTE259M-C standard,  
BNC×3

### (Video output signals adjustment)

**Video gain:** ±3 dB  
**Chroma gain:** ±3 dB  
**Hue:** ±30°  
**Setup:** ±14 IRE  
**Sync phase:** ±15 μs  
**SC phase:** ±180°

## AUDIO

(Digital audio)  
**Sampling frequencies:** 48 kHz (synchronized with video signal)  
**Quantizing:** 16 bits  
**Frequency response:** 20 Hz to 20 kHz (±1.0 dB) (at reference level)  
**Dynamic range:** Better than 85 dB (1 kHz, emphasis OFF, "A" weighted)  
**Distortion:** Less than 0.1% (1 kHz, emphasis OFF, standard level)  
**Crosstalk:** Less than –80 dB (1 kHz, between 2 channels)  
**Wow & flutter:** Below measurable limits  
**Headroom:** 20 dB  
**De-emphasis:** T1=50 μs/T2=15 μs (on/off automatic)

### (Audio input connector)

**Analog input (CH1/CH2):** XLR×2, 600Ω/high impedance selectable, +4/0/–20/–60 dBu  
**Digital input (CH1/CH2):** BNC×1, AES/EBU format  
**Serial digital input (option):** Complies with SMPTE259M-C, 272M-A standard (BNC, 75Ω)

### (Audio output connector)

**Analog output (CH1/CH2):** XLR×2, low impedance, +4/0/–20 dBu  
**Digital output (CH1/CH2):** BNC×1, AES/EBU format  
**Serial digital output (option):** Complies with SMPTE259M-C, 272M-A standard (BNC, 75Ω)  
**Monitor output:** Phono×1, 600Ω, –8 dBV  
**Headphones:** Variable level, 1/4" phone, 8Ω

## Other input/output connector

**Time code input:** BNC×1, 0.5 V<sub>p-p</sub> to 8 V<sub>p-p</sub>, 10 kΩ  
**Time code output:** BNC×1, 2.0 V<sub>p-p</sub> ±0.5 V<sub>p-p</sub>, low impedance

**RS-422A input/output:** D-sub 9-pin, RS-422A interface  
**RS-232C:** D-sub 25-pin, RS-232C interface  
**Encoder remote:** D-sub 15-pin

**Digital video interface input/output (option):** Compliant with IEEE 1394-1995 standard,  
6 pins × 1

Weight and dimensions when shown are approximately.  
Specifications are subject to change without notice.

---

# Panasonic

**PANASONIC BROADCAST & TELEVISION SYSTEMS COMPANY**  
DIVISION OF MATSUSHITA ELECTRIC CORPORATION OF AMERICA

**Executive Office:**

3330 Cahuenga Blvd W., Los Angeles, CA 90068 (323) 436-3500

**EASTERN ZONE:**

One Panasonic Way 4E-7, Secaucus, NJ 07094 (201) 348-7621

**Southeast Region:**

1225 Northbrook Parkway, Ste 1-160, Suwanee, GA 30024 (770) 338-6835

**Central Region:**

1707 N Randall Road E1-C-1, Elgin, IL 60123 (847) 468-5200

**WESTERN ZONE:**

3330 Cahuenga Blvd W., Los Angeles, CA 90068 (323) 436-3500

**Government Marketing Department:**

52 West Gude Drive, Rockville, MD 20850 (301) 738-3840

**Broadcast PARTS INFORMATION & ORDERING:**

9:00 a.m. – 5:00 p.m. (EST) (800) 334-4881/24 Hr. Fax (800) 334-4880

Emergency after hour parts orders (800) 334-4881

**TECHNICAL SUPPORT:**

Emergency 24 Hour Service (800) 222-0741

**Panasonic Canada Inc.**

5770 Ambler Drive, Mississauga, Ontario L4W 2T3 (905) 624-5010

**Panasonic de Mexico S.A. de C.V.**

Av angel Urraza Num. 1209 Col. de Valle 03100 Mexico, D.F. (52) 1 951 2127

**Panasonic Sales Company**

**Division of Matsushita Electric of Puerto Rico Inc.**

San Gabriel Industrial Park, 65th Infantry Ave., Km. 9.5, Carolina, Puerto Rico 00630 (787) 750-4300